



Transport  
Canada

Transports  
Canada

C O N S T R U C T I O N   S T A N D A R D S   F O R   S M A L L   V E S S E L S

**TP1332**

**2004 Edition**

\* NOTE: With the coming into force of the new *Small Vessel Regulations* on April 29, 2010, the 2004 edition of the Construction Standards for Small Vessels, TP1332, is replaced by the 2010 edition of the same document. The 2004 edition is provided as a reference for vessels built before April 29, 2010. For more information on the application of the Construction Standard for Small Vessels, TP1332 refer to the *Small Vessel Regulations*.

Canada 



Transport  
Canada  
Safety and Security

Transports  
Canada  
Sécurité et sûreté

## Contact Information

### Pleasure Craft Compliance

#### Office of Boating Safety

Tower C, Place de Ville  
11th Floor  
330 Sparks Street  
Ottawa, Ontario K1A 0N8  
Canada

**Tel.:** (613) 990-5940  
**Toll free:** 1-800-267-6687  
**Fax:** (613) 991-4818  
**E-Mail:** [obs-bsn@tc.gc.ca](mailto:obs-bsn@tc.gc.ca)  
**Web Site:** [www.boatingsafety.gc.ca](http://www.boatingsafety.gc.ca)

### Non-Pleasure Craft Compliance

#### Marine Safety

Tower C, Place de Ville  
11th Floor  
330 Sparks Street  
Ottawa, Ontario K1A 0N8  
Canada

**Tel.:** (613) 991-3135  
**Fax:** (613) 990-6191  
**E-Mail:** [MarineSafety@tc.gc.ca](mailto:MarineSafety@tc.gc.ca)  
**Web Site:** [www.tc.gc.ca/marinesafety](http://www.tc.gc.ca/marinesafety)

Archived

**Contents**

	Contact Information . . . . .	i
	Contents . . . . .	iii
	Referenced Organizations . . . . .	x
	Pleasure Craft and Non-Pleasure Craft Application by Section and Subsection . . . . .	xiii
<b>1.0</b>	<b>General . . . . .</b>	<b>1</b>
1.1	Introduction . . . . .	2
1.2	Definitions . . . . .	2
1.3	Application . . . . .	6
<b>2.0</b>	<b>Pleasure Craft Identification and Compliance . . . . .</b>	<b>9</b>
2.1	Application . . . . .	10
2.2	Hull Identification Number (HIN) . . . . .	10
2.2.1	General . . . . .	10
2.2.2	Identification Code . . . . .	10
2.2.2.1	General . . . . .	10
2.2.2.2	Manufacturer’s Identification Code (MIC) . . . . .	10
2.2.2.3	Manufacturer’s Hull Number . . . . .	10
2.2.2.4	Date of Manufacture . . . . .	11
2.2.2.5	Country Code . . . . .	11
2.2.2.6	Marking of the Hull . . . . .	11
2.3	Safety Compliance Notice . . . . .	12
2.3.1	General . . . . .	12
2.3.2	Conformity Label . . . . .	12
2.3.2.1	General . . . . .	12
2.3.2.2	Example of Marked Information . . . . .	12
2.3.3	Capacity Label . . . . .	13
2.3.3.1	General . . . . .	13
2.3.3.2	Example of Marked Information . . . . .	13
2.3.3.3	Recommended Maximum Safety Requirements for Monohull, Multihull, and Inflatable Pleasure Crafts to be Marked on Capacity Label . . . . .	14
2.3.4	Single Vessel Label . . . . .	14

2.3.4.1	General	14
2.3.4.2	Example of Marked Information	15
<b>3.0</b>	<b>Construction Requirements</b>	<b>17</b>
3.1	Application	18
3.2	Strength	18
3.3	Fittings and Through-hull Openings	18
3.4	Doors, Hatches, Windows, and Port Lights	19
3.5	Ballast	19
3.6	Personal Watercraft	20
3.6.1	Alternative Construction Standards	20
3.6.2	Warning Label for the Ventilation of the Engine Compartment	20
3.7	Navigation Lights	20
3.8	Precautions against falls	20
3.8.1	Application	20
3.8.2	Bulwarks, Guardrails, Stanchions, etc.	21
3.9	Guard Rails and Grab Rails	21
3.9.1	Application	21
3.10	Pollution Discharge Advisory	21
<b>4.0</b>	<b>Hull Design Requirements</b>	<b>23</b>
4.1	Application	24
4.2	Monohull Vessels	24
4.2.1	General	24
4.2.2	Motor Well	24
4.2.3	Recommended Maximum Load Calculation (Intact Condition)	24
4.2.4	The Recommended Maximum Number of Persons	25
4.2.5	Recommended Maximum Power Calculation	25
(A)	Power Calculation for Manufacturers, Constructors, and Importers of monohull small vessels	25
(B)	Power Calculation for Vessel Owners and Brokers of monohull small vessels	29
4.2.6	Power Rating Restriction (Racing Hydroplanes)	32
4.2.7	Minimum Flotation Test (Swamped Condition)	32
4.2.7.1	Application	32

4.2.7.2	Requirements for Minimum Flotation Test	32
4.2.7.3	Formulas for Minimum Flotation Test	34
4.2.7.4	Flotation Material	35
4.2.8	Level Flotation and Stability Tests (Swamped Condition)	35
4.2.8.1	Application	35
4.2.8.2	Preconditioning for Level Flotation Test	35
4.2.8.3	Person-Carrying Area	36
4.2.8.4	Requirements for Level Flotation Test	38
4.2.8.5	Preconditioning for Stability Test	38
4.2.8.6	Requirements for Stability Test	39
4.3	Multihull Small Vessels (Pontoon)	40
4.3.1	Calculation Criteria (Intact Condition)	40
4.3.2	Recommended Maximum Load Calculation	41
4.3.3	The Recommended Number of Persons	41
4.3.4	The Recommended Maximum Power	42
4.4	Small Vessels – Inflatable and Rigid Inflatable	42
4.4.1	Calculation Criteria (Intact Condition)	42
4.4.2	Recommended Maximum Load Calculation	42
4.4.3	Recommended Maximum Number of Persons	43
4.4.4	The Recommended Maximum Power	43
<b>5.0</b>	<b>Hull Design Requirements for Non-Pleasure Craft Exceeding 6 Metres</b>	<b>45</b>
5.1	Application	46
5.2	Stability	46
5.3	Drainage	46
<b>6.0</b>	<b>Ventilation Systems</b>	<b>47</b>
6.1	Application	48
6.2	General	48
6.3	Gasoline Engine and Fuel Gasoline Space Ventilation	48
6.3.1	Application	48
6.3.2	Removal of Combustible Vapours	48
6.3.3	Open Spaces Vessel Construction	48

6.3.4	Closed Spaces Vessel Construction .....	49
6.3.5	Underway Ventilation .....	50
6.3.6	Ducts .....	50
6.3.7	Cowls and Ventilation Openings .....	51
6.3.8	Blowers .....	51
6.4	Diesel Engine and Diesel Fuel Tank Space Ventilation .....	52
6.4.1	Application .....	52
6.4.2	General .....	52
6.5	Battery Spaces .....	52
<b>7.0</b>	<b>Fuel Systems .....</b>	<b>53</b>
7.1	Application .....	54
7.2	General .....	54
7.3	Fuel Tanks .....	55
7.3.1	General .....	55
7.3.2	Fuel Tank Installation .....	58
7.3.3	Fuel Tank Gauges .....	59
7.3.4	Fuel Tank Fill System .....	59
7.3.5	Fuel Tank Venting Systems .....	60
7.4	Fuel Lines .....	60
7.5	Fittings, Joints, and Connections .....	62
7.6	Fuel Line Valves .....	63
7.7	Fuel Filters and Strainers .....	64
7.8	Fuel Pumps .....	64
7.9	Grounding .....	65
7.10	Carburetors (Gasoline) .....	65
7.11	Fuel System Labeling .....	66
7.12	Outboard Motor Installations .....	66

<b>8.0</b>	<b>Electrical Systems</b> .....	<b>67</b>
8.1	Application .....	68
8.2	Alternative .....	68
8.3	General .....	68
8.4	Ignition Protection .....	70
8.5	Grounding .....	71
8.6	Batteries .....	72
8.6.1	General .....	72
8.6.2	Battery Disconnect Switch .....	73
8.7	Conductors .....	73
8.7.1	General – Systems less than 50 Volts .....	73
8.7.2	Wire Colour Coding .....	75
8.7.3	Secondary Circuits of Ignition Systems .....	77
8.7.4	Conductors – Support and Protection .....	77
8.7.5	Conductors – Termination .....	81
8.8	Receptacles .....	83
8.9	Overcurrent Protection .....	83
8.9.1	General .....	83
8.9.2	Special Applications .....	84
8.10	Panelboards .....	84
8.11	Non-Pleasure Craft Electrical Arrangements .....	84
8.11.1	Application .....	84
8.11.2	Emergency Lighting for Non-Pleasure Craft Only .....	84
8.11.3	Cables and Connectors .....	85
8.12	Electrical Systems of 50 Volts or More – Pleasure Craft Only .....	85
8.12.1	Application .....	85
8.12.2	General .....	85
8.13	Conductors in Circuits of 50 Volts or More – Non-Pleasure Craft .....	86

<b>9.0</b>	<b>Machinery Systems</b> .....	<b>87</b>
9.1	Propulsion Engines and Systems .....	88
9.1.1	Application .....	88
9.1.2	General .....	88
9.1.3	Engine Starting .....	88
9.1.4	Operating Station Controls and Gauges .....	88
9.1.5	Gasoline Engines Ventilation and Instructions .....	88
9.1.6	Shafting and Propellers .....	89
9.1.7	Exhaust Systems – All Small Vessels .....	89
9.1.7.1	Application .....	89
9.1.7.2	General .....	89
9.1.7.3	Materials .....	89
9.1.8	Steering Systems .....	90
9.2	Auxiliary Machinery .....	90
9.2.1	Bilge Pumping Arrangements .....	90
9.2.1.1	Application .....	90
9.2.1.2	General .....	91
9.2.1.3	Where a Piping System Is Fitted .....	91
9.2.2	Pressure Vessels .....	91
<b>10.0</b>	<b>Fire Protection Systems</b> .....	<b>93</b>
10.1	Application .....	94
10.2	General .....	94
10.3	Means of Escape .....	94
10.4	Fire Detection .....	94
10.5	Fire Extinguishing .....	95
<b>A1.0</b>	<b>Appendix 1: Compliance Process and Forms for Manufacturers and Importers of New Pleasure Craft</b> .....	<b>97</b>
A1.1	Safety Label Compliance Process for New Pleasure Crafts .....	98
A1.2	New Pleasure Craft Not Exceeding 6 Metres .....	98
A1.3	New Pleasure Craft Exceeding 6 Metres .....	100

A1.4	Ordering Labels (Repeat Orders) . . . . .	100
	Statutory Declaration . . . . .	101
	Small Vessel Information Form for Manufacturers . . . . .	103
	Small Vessel Information Form for Manufacturers – Definitions . . . . .	105
	Classification Codes . . . . .	106
	Application for Vessel Capacity Label and Measurement Forms (Monohulls) . . . . .	107
A1.5	Instructions for Measuring Monohull Small Vessels – Long Method . . . . .	111
	Application for Multihull Vessel Capacity Label . . . . .	115
	Application for Inflatable Craft Capacity Label . . . . .	117
	Capacity Label Order Form . . . . .	119
	Conformity Label Order Form . . . . .	121
<b>A2.0</b>	<b>Appendix 2: Compliance Process and Forms for Pleasure Craft Owners and Brokers of Second-Hand Pleasure Craft . . . . .</b>	<b>123</b>
A2.1	Pleasure Craft Safety Label Compliance Process for Pleasure Craft Owners and Brokers of Second-Hand Pleasure Craft, Regardless of Length . . . . .	124
	Single Vessel Data Sheet . . . . .	127
	Classification Codes . . . . .	129
	Application for Single Vessel Label for Monohull Vessels Under 6 Metres (19 ft 8 in) in Length . . . . .	131
	Application for Single Vessel Label for Multihull Vessels Under 6 Metres (19 ft 8 in) in Length . . . . .	133
	Application for Single Vessel Label for Inflatable Vessels Under 6 Metres (19 ft 8 in) in Length . . . . .	135
<b>A3.0</b>	<b>Appendix 3: Sewage Holding Tank Systems (Voluntary) . . . . .</b>	<b>137</b>
A3.1	System Design . . . . .	138
A3.2	Portable Toilets . . . . .	138
A3.3	Holding Tank Systems . . . . .	138
<b>A4.0</b>	<b>Appendix 4: Noise Reduction on Power-Driven Small Vessels . . . . .</b>	<b>143</b>
A4.1	Small Vessels Noise Abatement Mechanism . . . . .	144

**Referenced Organizations****ABYC**

*American Boat & Yacht Council*

3069 Solomon's Island Road

Edgewater, Maryland 21037-1416, U.S.

Telephone: (410) 956-1050

**ASTM**

*American Society for Testing and Materials*

1916 Race Street

Philadelphia, Pennsylvania 19103-1187, U.S.

Telephone: (215) 299-5400

**CSA**

*Canadian Standards Association*

5060 Spectrum Way

Mississauga, Ontario L4W 5N6, Canada

Telephone: (416) 747-4000

**CFR**

*Code of Federal Regulations*

(and other U.S. Government publications)

Superintendent of Documents

United States Government Information

P. O. Box 371 954

Pittsburgh, Pennsylvania 15250-7954, U.S.

Telephone: (202)-512-1800

**IEEE**

*Institution of Electrical & Electronics Engineers Inc.*

445 Hoes Lane

Piscataway, New Jersey 08854, U.S.

Telephone: (732)-981-0060

**ISO**

*International Organisation for Standardisation*

1, rue de Varembe, Case postale 56, CH-1211

Genève 20, Switzerland:

*Standards Council of Canada*

(Canadian Representative)

270 Albert Street, Suite 200

Ottawa, Ontario K1P 6N7, Canada

Telephone: (613) 238-3222

*Publications from: Global Info Centre Canada*

240 Catherine Street, Suite 305

Ottawa, Ontario K2P 2G8, Canada

Telephone: (613) 237-4250

Fax: (613) 237-4251

**SAE**

*Society of Automotive Engineers*

400 Commonwealth Drive

Warrendale, Pennsylvania 15096-0001, U.S.

Telephone: (412) 776-4841

Fax: (412) 776-5760

Archived

**UL**

*Underwriters Laboratories Marine Department*

12 Laboratory Drive

P. O. Box 13995

Research Triangle Park, North Carolina 27709, U.S.

Telephone: (919) 549-1400

*Publications from: Global Engineering Documents Inc.*

15 Inverness Way East

Englewood, Colorado 80112, U.S.

Telephone: 1-800-854-7179

**ANSI**

*American National Standards Institute*

25 West 43rd Street, 4th floor

New York, New York 10036, U.S.

Telephone: (212) 642-4900

Fax: (212) 398-0023

Archived

<b>Pleasure Craft and Non-Pleasure Craft Application by Section and Subsection</b>			
<b>Section / Subsection</b>		<b>Pleasure Craft</b>	<b>Non-Pleasure Craft</b>
<b>1.0</b>	<b>General</b>		
1.1	Introduction	■	■
1.2	Definitions	■	■
1.3	Application	■	■
<b>2.0</b>	<b>Vessel Identification and Compliance</b>		
2.1	Application	■	
2.2	Hull Identification Number (HIN)	■	
2.2.1	General	■	
2.2.2	Identification Code	■	
2.3	Safety Compliance Notice	■	
2.3.1	General	■	
2.3.2	Conformity Label	■	
2.3.3	Capacity Label	■	
2.3.4	Single Vessel Label	■	
<b>3.0</b>	<b>Construction Requirements</b>		
3.1	Application	■	■
3.2	Strength	■	■
3.3	Fittings and Through-hull Openings	■	■
3.4	Doors, Hatches, Windows, and Port Lights	■	■
3.5	Ballast	■	■
3.6	Personal Watercraft	■	■
3.6.1	Alternative Construction Standards	■	■
3.6.2	Warning Label for the Ventilation of the Engine Compartment	■	■
3.7	Navigation Lights	■	■
3.8	Precautions Against Falls		■
3.8.1	Application		■
3.8.2	Bulwarks, Guardrails, Stanchions, etc.		■
3.9	Guard Rails and Grab Rails	■	
3.9.1	Application	■	
3.10	Pollution Discharge Advisory	■	■
<b>4.0</b>	<b>Hull Design Requirements</b>		
4.1	Application	■	■
4.2	Monohull Vessels	■	■
4.2.1	General	■	■
4.2.2	Motor Well	■	■
4.2.3	Recommended Maximum Load (Intact Condition) Calculation	■	■
4.2.4	The Recommended Maximum Number of Persons	■	■
4.2.5	Recommended Maximum Power Calculation	■	■
(A)	Power Calculation for Manufacturers, Constructors, and Importers of Monohull Small Vessels	■	■

Section / Subsection		Pleasure Craft	Non-Pleasure Craft
(B)	Power Calculation for Pleasure Craft Owners and Monohull Second Hand Pleasure Craft Brokers	■	■
4.2.6	Power Rating Restriction (Racing Hydroplanes)	■	■
4.2.7	Minimum Flotation Test (Swamped Condition)	■	■
4.2.8	Level Flotation and Stability Tests (Swamped Condition)	■	■
4.3	Multihull Small Vessels	■	■
4.3.1	Calculation Criteria (Intact Condition)	■	■
4.3.2	Recommended Maximum Load Calculation	■	■
4.3.3	The Recommended Number of Persons	■	■
4.3.4	The Recommended Maximum Power	■	■
4.4	Inflatable and Rigid Inflatable Crafts	■	■
4.4.1	Calculation Criteria (Intact Condition)	■	■
4.4.2	Recommended Maximum Load Calculation	■	■
4.4.3	Recommended Maximum Number of Persons	■	■
4.4.4	The Recommended Maximum Power	■	■
<b>5.0</b>	<b>Hull Design Requirements for Non Pleasure Craft Over 6 m</b>		
5.1	Application		■
5.2	Stability		■
5.3	Drainage		■
<b>6.0</b>	<b>Ventilation Systems</b>		
6.1	Application	■	■
6.2	General	■	■
6.3	Gasoline Engine and Fuel Tank Space Ventilation	■	■
6.3.1	Application	■	■
6.3.2	Removal of Combustible Vapours	■	■
6.3.3	Open Spaces Vessel Construction	■	■
6.3.4	Closed Spaces Vessel Construction	■	■
6.3.5	Underway Ventilation	■	■
6.3.6	Ducts	■	■
6.3.7	Cowls	■	■
6.3.8	Blowers	■	■
6.4	Diesel Engine and Fuel Tank Space Ventilation	■	■
6.4.1	Application	■	■
6.4.2	General	■	■
6.5	Battery Spaces	■	■
<b>7.0</b>	<b>Fuel Systems</b>		
7.1	Application	■	■
7.2	General	■	■
7.3	Fuel Tanks	■	■
7.3.1	General	■	■
7.3.2	Fuel Tank Installation	■	■

Section / Subsection		Pleasure Craft	Non-Pleasure Craft
7.3.3	Fuel Tank Gauges	■	■
7.3.4	Fuel Tank Fill System	■	■
7.3.5	Fuel Tank Venting Systems	■	■
7.4	Fuel Lines	■	■
7.5	Fittings, Joints, and Connections	■	■
7.6	Fuel Line Valves	■	■
7.7	Fuel Filters and Strainers	■	■
7.8	Fuel Pumps	■	■
7.9	Grounding	■	■
7.10	Carburetors (Gasoline)	■	■
7.11	Fuel System Labeling	■	■
7.12	Outboard Motor Installations	■	■
<b>8.0</b>	<b>Electrical Systems</b>		
8.1	Application	■	■
8.2	Alternative	■	■
8.3	General	■	■
8.4	Ignition Protection	■	■
8.5	Grounding	■	■
8.6	Batteries	■	■
8.6.1	General	■	■
8.6.2	Battery Disconnect Switch	■	■
8.7	Conductors	■	■
8.7.1	General – Systems less than 50 Volts	■	■
8.7.2	Wire Colour Coding	■	■
8.7.3	Secondary Circuits of Ignition Systems	■	■
8.7.4	Conductors – Support and Protection	■	■
8.7.5	Conductors – Termination	■	■
8.8	Receptacles	■	■
8.9	Overcurrent Protection		■
8.9.1	General	■	■
8.9.2	Special Applications	■	■
8.10	Panelboards	■	■
8.11	Non-Pleasure Craft Electrical Arrangements		■
8.11.1	Application		■
8.11.2	Emergency Lighting for Non-Pleasure Craft Only		■
8.11.3	Cables and Connectors		■
8.12	Electrical Systems of 50 Volts or More – Pleasure Craft Only	■	
8.12.1	Application	■	
8.12.2	General	■	
8.13	Conductors in Circuits of 50 Volts or More – Non-Pleasure Craft		■

Section / Subsection		Pleasure Craft	Non-Pleasure Craft
<b>9.0</b>	<b>Machinery Systems</b>		
9.1	Propulsion Engines and Systems		■
9.1.1	Application		■
9.1.2	General		■
9.1.3	Engine Starting		■
9.1.4	Operating Station Controls and Gauges		■
9.1.5	Gasoline Engines Ventilation and Instructions		■
9.1.6	Shafting and Propellers		■
9.1.7	Exhaust Systems	■	■
9.1.8	Steering Systems		■
9.2	Auxiliary Machinery		■
9.2.1	Bilge Pumping Arrangements		■
9.2.2	Pressure Vessels		■
<b>10.0</b>	<b>Fire Protection Systems</b>		
10.1	Application		■
10.2	General		■
10.3	Means of Escape		■
10.4	Fire Detection		■
10.5	Fire Extinguishing		■
<b>A1.0</b>	<b>Compliance Process and Forms for Manufacturers and Importers of New Pleasure Craft</b>	■	
<b>A2.0</b>	<b>Compliance Process and Forms for Pleasure Craft Owners and Brokers of Second-Hand Pleasure Craft</b>	■	
<b>A3.0</b>	<b>Sewage Holding Tank Systems (Voluntary)</b>	■	■
<b>A4.0</b>	<b>Noise Reduction on Power-Driven Small Vessels</b>	■	■

**Section 1.0**

**G E N E R A L**

**ISSUE NUMBER: 3**

**DATE: 2004 Edition**

**NUMBER OF PAGES: 6**

**THIS ISSUE SUPERSEDES**

Issue Number: 2

Dated: January 2002

Archived

## 1.0 Introduction

- 1.1.1 The *Construction Standards for Small Vessels* – TP1332, 2004 Edition, has been developed for every small vessel that operates as a pleasure craft or non-pleasure craft, intended to operate in Canadian waters, and supersedes the *Construction Standards for Small Vessels* – TP1332, 2002 Edition.
- 1.1.2 The responsibility for the application of this Standard with respect to both pleasure craft and non-pleasure craft lies with Transport Canada Marine Safety.
- 1.1.3 This Standard derives its authority from the *Small Vessel Regulations* made under the *Canada Shipping Act*, as amended from time to time, either in whole or in part.
- 1.1.4 It is the responsibility of a small vessel designer, manufacturer, constructor or owner to carefully consider the intended operation of the vessel when determining its construction, watertight integrity, and stability. When selecting materials and equipment, the responsible person shall ensure that such items meet the working and environmental conditions the vessel may encounter.
- 1.1.5 Criteria are derived from good boat building practices and awareness of the need for the safety of boaters and the protection of the marine environment. In this regard, it is the intention of this Standard to meet the practical needs of the industry.
- 1.1.6 The long-term goal is the harmonization of this Standard with the standards of both ABYC (American Boat & Yacht Council), whose assistance in drafting referenced sections is acknowledged, and ISO (International Organisation for Standardisation), as appropriate. Where standards from other organizations are referenced, they may be obtained from the addresses listed (see “Referenced Organizations”).
- 1.1.7 The application of the various sections of this Standard with respect to non-pleasure craft versus pleasure craft are identified at the beginning of each section. Each part of this Standard is to be considered separate.
- 1.1.8 The conversions shown in this Standard have been done using a “soft” conversion method or rounded to nearest millimetre. The conversions shown are only for numbers that have been incorporated into the Standard as imperial. Numbers and measures incorporated in metric have not been converted.

## 1.2 Definitions

- 1.2.1 In this Standard:
- “**Act**” means the *Canada Shipping Act*;
- “**Accessible**” means capable of being reached for inspection, maintenance, or usage under emergency conditions without the use of tools or removal of permanent craft structure;

“**Bilge**”, in respect of flotation material, means that area of the small vessel below a height of 100 mm (4 in) measured from the lowest point in the vessel, except for engine rooms, where liquid can collect when the vessel is in the static floating position;

“**Bow Reference Area**”, for the purpose of the level flotation and stability requirements for outboard power-driven small vessels, not over six (6) metres, means the area 0.6 m (2 ft) aft of the stem of the vessel, measured at the top deck or gunwale level;

“**Calculation Length**”, for power-driven small vessels, means the length, measured parallel to the static float plane (SFP), between two vertical planes normal to the centre line of the craft, erected from the foremost integral part of the hull, and erected aft through a point located on the transom at the midpoint between the SFP and the hull bottom (see Figure 4–1);

“**Connected compartments**” means two compartments connected in a manner that allows a flow of water in excess of 7.5 mL/h ( $1/4$  U.S. fl oz/hr) from one compartment to the other compartment;

“**Designated Occupant Position**” means a specific location for a person within a small vessel, being either a seat or a location for standing with handholds;

“**Engine Power**” means the engine power, in kilowatts, calculated in accordance with ISO 8665, *Marine Propulsion Engines and Systems – Power Measurements and Declarations*;

“**Engine Space**” means any compartment that contains a permanently installed engine, or engines, including connected compartments;

“**Engine Space Bilge**”, in respect of flotation material, means that area in the engine room or a connected compartment below a height of 305 mm (12 in), measured from the lowest point in those compartments where liquid can collect when the vessel is in a static floating position;

“**Gross Load**” is a numerical value as calculated for each hull type as listed below:

- (a) for Monohull small vessels, see calculation subsection 4.2.3.1;
- (b) for Multihull small vessels, see calculation subsection 4.3.2.1;
- (c) for Inflatable small vessels, see calculation subsection 4.4.2.1;

“**Grounded Conductor**” means a current carrying conductor that is connected to one side of the power source that is intentionally maintained at ground potential;

“**Grounding Conductor**” (green or green with yellow stripe) means a non-current carrying conductor employed to connect the metallic non-current carrying parts of electrical equipment to the DC system or engine negative terminal;

“**Ground**” means the potential of the earth’s surface in which the vessels ground is established by a connection with earth including the conductive part of the wetted hull’s surface;

“**Ignition Protection**” means the design and construction of a device such that under design operating conditions it will not ignite a flammable hydrocarbon mixture surrounding the device when an ignition source causes an internal explosion, or it is incapable of releasing sufficient electrical or thermal energy to ignite a hydrocarbon, or the source of ignition is hermetically sealed;

“**ISO 11812**” means ISO Standard 11812, *Small Craft – Watertight Cockpits and Quick Draining Cockpits*;

“**ISO 12216**” means ISO Standard 12216, *Small Craft Windows, Port Lights, Hatches, Deadlights and Doors – Strength and Tightness Requirements*;

“**ISO 12217-1**” means ISO Standard 12217-1 *Small Craft – Stability and Buoyancy Assessment and Categorization*, Part 1 – “Non-Sailing Vessels of Hull Length Greater Than or Equal to 6 Metres”;

“**Length**” ( $L_H$ ) means the distance measured from the forward end of the foremost outside surface of the hull shell to the aft end of the aftermost outside surface of the hull shell (see Figure 1-1);

“**Live Load**”, for the purpose of the requirements of monohull vessel minimum flotation test, means that part of the maximum load that is taken up by persons that may be carried in a given hull, considered to be 60% of that weight which when placed along the outer edge of either side of the person-carrying area would heel the vessel to the maximum angle without taking water on board, resulting in down-flooding;

“**Maximum Load**”, for the purpose of the requirements of monohull vessel minimum flotation test, means the sum of all weights in kilograms that may be carried in a given hull, including persons, equipment, engine, controls, and fuel, and for the purpose of this Standard, is considered to be 20% of the displacement to the static float plane;

“**Midship Deadrise Angle**” is the angle, taken at midship, at which the hull slopes up from the horizontal (e.g., A flat bottom vessel has a deadrise angle of zero degrees; a high midship deadrise angle value indicates a deep V-hull);

“**Non-Pleasure Craft**” means a small vessel, as defined in the *Small Vessel Regulations*, that is not a pleasure craft or fishing vessel as defined in the *Small Fishing Vessel Inspection Regulations*;

“**Overcurrent Device**” means a device that is designed to interrupt the circuit when the current exceeds a predetermined value (e.g., circuit breakers or fuses);

“**Panelboard**” means an enclosure or assembly that contains devices such as circuit breakers, fuses, switches, and instruments designed to distribute or protect the distribution of power in the vessel;

“**Permanently Installed**” means securely fastened so that tools need to be used for removal;

“**Personal Watercraft**” means a vessel as defined in the *Small Vessel Regulation*;

“**Pleasure Craft**”, as defined in the *Canada Shipping Act*, means a vessel used by an individual for pleasure and not for a commercial purpose;

“**Power Rating**” is the maximum engine power rated in kilowatts (and horsepower) based on Section 4 of this Standard;

“**Recommended Safe Limit**” means calculated limits according to the formulae set out in this Standard as applied to maximum gross load (GL), number of adult persons, or safe engine power limits;

“**Remote control**”, for the purpose of the requirements of steering systems, means any steering arrangement other than an outboard motor fitted with a tiller or a rudder with tiller arrangements;

“**Sealed Compartment**”, for the purpose of the requirements of monohull vessel minimum flotation test, means an enclosure that can resist an exterior water level of 305 mm (12 in) without seepage of more than 7.5 mL/h ( $\frac{1}{4}$  U.S. fl oz/hr);

“**Standard**” means the *Construction Standards for Small Vessels* – TP1332, unless another standard is specified;

“**Static Float Plane**” (SFP) means the plane located below all points of major leakage and the most forward point of the small vessel below which the maximum displacement of the vessel exists, see figure 4–1; alternatively, it may be defined as the plane passing below all points of major leakage at equal distances either above or below the intersections of the sheer with the stem and stern (transom) when the vessel is transversely level. The intersections are determined when the vessel is longitudinally level, by being supported on its keel at points that are 40% and 75% of the vessel’s overall length, aft of the bow, and are at points where a line that is 45 degrees to a level floor is tangent to the bow and stern of the vessel;

“**Static Floating Position**” means the attitude in which a small vessel floats in calm water with each fuel tank filled to its rated capacity, but with no person or item of portable equipment on board, with other tanks such as water and holding tanks empty, and permanently installed equipment supplied by the vessel builder in its proper place;

“**Stern Reference Area**”, for the purpose of the level flotation and stability requirements for outboard power-driven small vessels, not over six (6) metres, means that area 0.6 m (2 ft) forward of the transom or engine mount, measured at the top deck or gunwale level;

“**Switchboard**” means an enclosure so constructed to control and distribute electrical power to panelboards and other electrical equipment within the vessel, included in the enclosure are electrical devices such as circuit breakers, fuses, switches, indicating devices, meters, and instruments;

“**Trip-free Circuit Breaker**” means a resettable circuit breaker designed so that it is impossible to override the current interrupting mechanism;

“**Watertightness**”, as defined by ISO 12216, means the ability of an appliance, fitting, or surface to resist ingress of water into the vessel;

“**Watertight Enclosure**”, as it applies to Section 8, “Electrical Systems,” means an enclosure that prevents the ingress of water when tested by subjecting it to a solid stream of water from a 25mm (one inch) inside diameter nozzle, at a pressure of 103.4 kPa (15 psi) at the nozzle, with the nozzle 3m (10 feet) away and a water temperature of approximately 10°C (50°F), for a period of five minutes.

“**Weatherproof**” means that equipment is so constructed or protected that exposure to the weather, to falling moisture or to external splashing will not impair the effectiveness of the enclosed equipment.

### 1.3 Application

- 1.3.1 All small vessels shall comply with this Standard as required by the *Small Vessel Regulations* made under the *Canada Shipping Act*.
- 1.3.2 Existing pleasure craft shall comply with this Standard insofar as it is reasonable and practicable to do so.
- 1.3.3 The application of the various sections of this Standard with respect to non-pleasure craft versus pleasure craft are identified at the beginning of each section under the subsection titled “Application.”

**Figure 1-1 Determination of Vessel Length ( $L_h$ )**

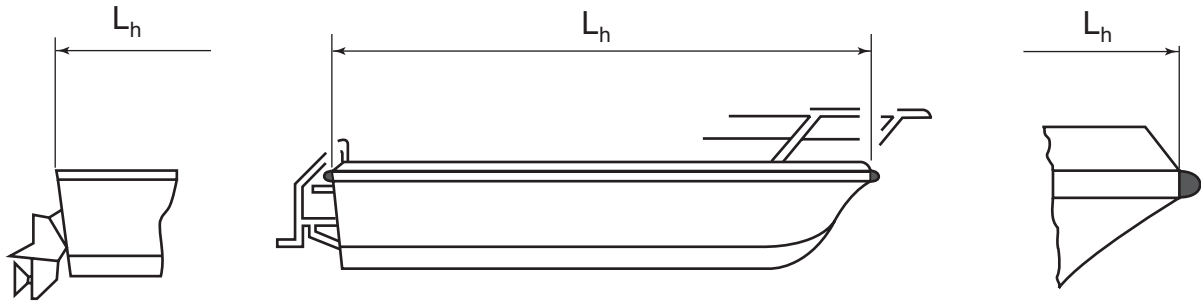

Monohull Powerboat with Add-on Swim Platform

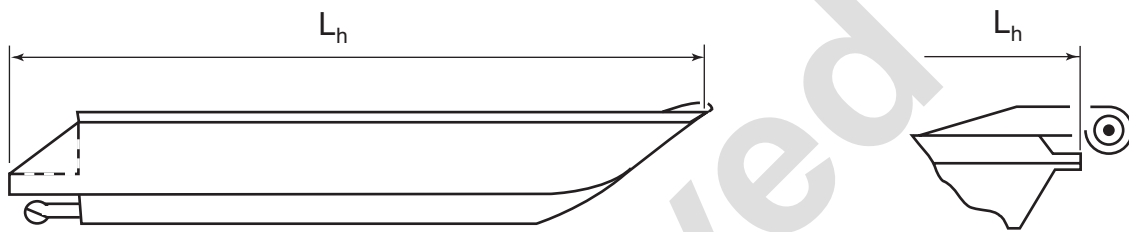

Monohull Powerboat with Built-in Swim Platform

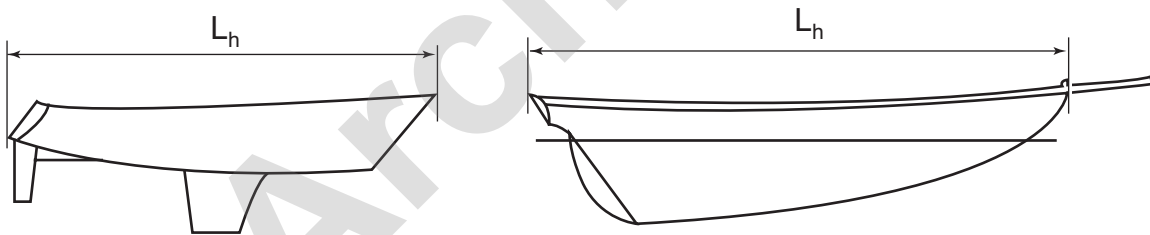

Fin Keel Sailboat

Full Keel Sailboat

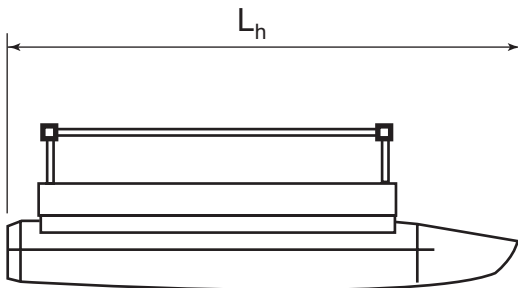

Multihull/Pontoon

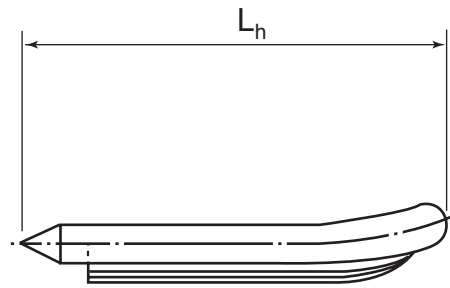

Inflatable/Rigid Inflatable

**Section 2.0**

**P L E A S U R E   C R A F T   I D E N T I F I C A T I O N   A N D   C O M P L I A N C E**

**ISSUE NUMBER: 3**

**DATE: 2004 Edition**

**NUMBER OF PAGES: 6**

THIS ISSUE SUPERSEDES

Issue Number: 2

Dated: January 2002

Archived

## 2.1 Application

2.1.1 This section applies in respect of pleasure craft.

## 2.2 Hull Identification Number (HIN)

### 2.2.1 General

2.2.1.1 The Hull Identification Number (HIN) provides a uniform method for identifying:

- (a) any specific pleasure craft;
- (b) the construction standards that apply to that specific pleasure craft;
- (c) pleasure craft subject to a manufacturer's defect recall; and
- (d) a lost or stolen pleasure craft.

### 2.2.2 Identification Code

#### 2.2.2.1 General

2.2.2.1.1 The identification code consists of 12 consecutive characters displayed as capital letters of the alphabet or Arabic numerals with no spaces, slashes (obliques), or hyphens between them. The code comprises:

- (a) a three-digit Manufacturer's Identification Code (MIC); followed by
- (b) a five character Manufacturer's Hull Serial Number; and
- (c) four figures giving the date of manufacture.

#### 2.2.2.2 Manufacturer's Identification Code (MIC)

2.2.2.2.1 The MIC consists of three characters displayed as block capitals or numbers, forming the first three characters of the HIN, as issued by Transport Canada, Marine Safety.

#### 2.2.2.3 Manufacturer's Hull Number

2.2.2.3.1 The fourth through eighth characters of the HIN are the individual Manufacturer's Hull Number, which is defined by the manufacturer.

2.2.2.3.2 No two pleasure craft shall be assigned the same Manufacturer's Hull Number.

2.2.2.3.3 The Manufacturer's Hull Number shall consist of capital letters of the alphabet or Arabic numerals, or both, except that the letters "I," "O," and "Q" shall not be used.

**2.2.2.4 Date of Manufacture**

2.2.2.4.1 The ninth through twelfth characters of the HIN indicate the date of manufacture. The ninth character is a capital letter of the alphabet indicating the month from when the pleasure craft is considered to have commenced construction and is defined as follows:

A = January    B = February    C = March    D = April    E = May    F = June  
 G = July    H = August    I = September    J = October    K = November    L = December

2.2.2.4.2 The tenth is an Arabic numeral designating the last digit of the year of manufacture.

2.2.2.4.3 Characters eleven and twelve are Arabic numerals marking the model year of the pleasure craft.

<b>Table 2-1 Example of Twelve-Digit Hull Identification Number (HIN)</b>			
ABC2AB41G091			
Manufacturer's Identification Code	Manufacturer's Hull Number	Commencement of Construction	Model Year
ABC	2AB41	G0	91

*Note on Table 2-1*

1. Table 2-1 is a typical example of a complete twelve digit HIN for a pleasure craft where construction commenced in July 1990 for the 1991 model year.

**2.2.2.5 Country Code**

2.2.2.5.1 The country code is an optional addition to the HIN (ISO 10087 *Small Craft – Hull Identification – Coding System*).

2.2.2.5.2 Manufacturers and constructors of pleasure craft have the option of adding the Country Code prefix (e.g., “CA-” [block capitals and hyphen] for Canada) in front of the HIN. A typical example of a fifteen character HIN, including the Country Code, is CA-ABC2AB41G091.

2.2.2.5.3 The Country Code is a mandatory requirement for manufacturers exporting to some countries (e.g., countries of the European Community).

**2.2.2.6 Marking of the Hull**

2.2.2.6.1 The HIN shall be permanently affixed to the hull or hull member prior to the completion of construction. No character of the HIN is to be less than 6 mm (1/4 in) in height and width. The HIN shall be located:

- (a) on the upper starboard quarter of the transom; or

- (b) the starboard side at the aft end of the hull that bears the rudder or steering mechanism if the pleasure craft has no transom; or
- (c) the outermost starboard side at the after end of the hull, if the pleasure craft has more than one hull and no transom; or
- (d) the outermost starboard side at the aft end of the hull, if the vessel has no transom.

2.2.2.6.2 A duplicate hull identification number must be affixed in an unexposed location on the interior of the boat or beneath a fitting or item of hardware.

## 2.3 Safety Compliance Notice

### 2.3.1 General

2.3.1.1 Every pleasure craft capable of being fitted with an engine that is required to be constructed according to this Standard shall have fitted to it, in a conspicuous position, plainly visible from the helm (unless exempt by regulation), a Safety Compliance Notice issued by Transport Canada, Marine Safety.

2.3.1.2 A compliance Notice is defined as either

- (a) a Conformity Label,
- (b) a Capacity Label, or
- (c) a Single Vessel Label.

### 2.3.2 Conformity Label

#### 2.3.2.1 General



2.3.2.1.1 Every new pleasure craft capable of being fitted with an engine, which is not required to have a Capacity Label, shall have affixed to it a Conformity Label attesting to the fact that the vessel is built in accordance with this Standard.

#### 2.3.2.2 Example of Marked Information

2.3.2.2.1 The Conformity Label shall include the following:

- (a) name of manufacturer;
- (b) manufacturer's or constructor's identification code, MIC;
- (c) model type or number, or both;
- (d) label number; and
- (e) statement of compliance.

**Figure 2-1 Conformity Label Example**

 Transport Canada    Transports Canada		
<b>BUILDER-CONSTRUCTEUR</b>  ABC IMAGINARY CO. (AAA)	<b>MODEL-MODÈLE</b>  RUNABOUT 6,1 m	
The manufacturer certifies that this product complies with the pleasure craft requirements of the Construction Standards for Small Vessels	Le fabricant certifie que ce produit est conforme aux exigences des embarcations de plaisance de la Norme de construction des petits bateaux.	
NO. – no. <b>XXXX0016</b>		

### 2.3.3 Capacity Label

#### 2.3.3.1 General

2.3.3.1.1 Every new pleasure craft required to be constructed according to this Standard, which is not exceeding 6 m (19 ft 8 in) in length and is fitted with, or is capable of being fitted with, an engine power totaling 7.5 kW (10 hp) or more, shall have affixed to it a Capacity Label attesting to the fact that the vessel is built in accordance with these standards.



2.3.3.1.2 This requirement does not apply to personal watercraft, which shall have affixed a Conformity Label in accordance with subsection 2.3.2.

#### 2.3.3.2 Example of Marked Information

2.3.3.2.1 The Capacity Label shall include the following:

- (a) name of manufacturer;
- (b) Manufacturer's Identification Code, MIC;
- (c) model type or number, or both;
- (d) label number;
- (e) statement of compliance; and
- (f) maximum recommended ratings for:
  - (i) load,
  - (ii) people, and
  - (iii) engine power for outboard vessels.

**Figure 2-2 Capacity Label Example**

 Transport Canada / Transports Canada		
<b>MAXIMUM LOAD* CHARGE*</b>  500 kg 1100 lbs	<b>MAXIMUM # OCCUPANTS</b>  <b>5</b>	<b>MAXIMUM POWER PUISSANCE</b>  30 kW 40 hp
<small>*OCCUPANTS, GEAR    *OCCUPANTS, ÉQUIPEMENT</small>		<b>NO. – no. XXXX00006</b>
<b>BUILDER – CONSTRUCTEUR</b> ABC IMAGINARY CO. (YYY)		<b>MODEL – MODÈLE</b> RUNABOUT 6 m
<small>The manufacturer certifies that this product complies with the pleasure craft requirements of the Construction Standards for Small Vessels.          Le fabricant certifie que ce produit est conforme aux exigences des embarcations de plaisance de la Norme de construction des petits bateaux.</small>		

### 2.3.3.3 Recommended Maximum Safety Requirements for Monohull, Multihull, and Inflatable Pleasure Crafts to be marked on Capacity Label

2.3.3.3.1 Every outboard power-driven pleasure craft that conforms to subsection 2.3.3 shall have issued to it a Capacity Label on which the following ratings shall be marked:

- (a) the recommended maximum gross load capacity for that pleasure craft;
- (b) the recommended number of adult persons to be carried on the pleasure craft;
- (c) the recommended safe limits of engine power.

2.3.3.3.2 Every power-driven pleasure craft that is not outboard power-driven that conforms to subsection 2.3.3 shall have issued to it a Capacity Label on which the following ratings shall be marked:

- (a) the recommended maximum gross load for the pleasure craft;
- (b) the recommended number of adult persons to be carried on the pleasure craft.

## 2.3.4 Single Vessel Label

### 2.3.4.1 General

2.3.4.1.1 Every home-built pleasure craft capable of being fitted with an engine and required to be constructed according to this Standard shall have affixed to it a Single Vessel Label.

2.3.4.1.2 Every pleasure craft, capable of being fitted with an engine, manufactured, constructed or imported by a company no longer able to supply a label, which is required to be constructed according to this Standard, shall have affixed to it a Single Vessel Label.



**2.3.4.2 Example of Marked Information**

2.3.4.2.1 The single vessel label shall include the following information:



- (a) if the pleasure craft is manufactured or home-built;
- (b) model type;
- (c) label number; and
- (d) statement of requirement for compliance with this Standard.

**Important Note:** The labels for those vessels not exceeding 6 m (19 ft 8 in) in length will also contain capacity rating information similar to that put on the Capacity Label, see section 2.3.3.3.

**Figure 2-3 Single Vessel Label Example for Pleasure Craft Exceeding 6 Metres (without ratings)**

 Transport Canada / Transports Canada			
<b>BUILDER – CONSTRUCTEUR</b> MANUFACTURED OR HOMEBUILT		<b>MODEL – MODÈLE</b> OPEN VESSEL POWER 6.1 m	
This vessel shall meet the pleasure craft requirements of the Construction Standards for Small Vessels		Ce bâtiment doit être conforme aux exigences des embarcations de plaisance de la Norme de construction des petits bateaux.	
<b>H.I.N. # – ZZZAL340A498</b>			
NO. – no. <span style="border: 1px solid black; padding: 2px;">XXXX0045</span>			

**Figure 2-4 Single Vessel Label Example for Pleasure Craft Not Exceeding 6 Metres (with ratings)**

 Transport Canada / Transports Canada			
<b>BUILDER – CONSTRUCTEUR</b> MANUFACTURED OR HOMEBUILT		<b>OCCUPANTS</b> <div style="font-size: 2em; font-weight: bold; text-align: center;">5</div>	<b>MODEL-MODÈLE</b> OPEN VESSEL POWER 6.1 m
MAXIMUM LOAD CHARGE MAX.	500 kg 1100 lbs	MAXIMUM POWER PUISSANCE MAX.	30 kW 40 hp
LOAD INCL. OCCUPANTS, GEAR CHARGE INCL. OCCUPANTS, ÉQUIPEMENT		NO. – no. <span style="border: 1px solid black; padding: 2px;">XXXX0030</span>	
<b>H.I.N. # – QQQAL0010403</b>			
This vessel shall meet the pleasure craft requirements of the Construction Standards for Small Vessels		Ce bâtiment doit être conforme aux exigences des embarcations de plaisance de la Norme de construction des petits bateaux.	

**Section 3.0**

**C O N S T R U C T I O N   R E Q U I R E M E N T S**

**ISSUE NUMBER: 3**  
**DATE: 2004 Edition**  
**NUMBER OF PAGES: 4**

THIS ISSUE SUPERSEDES  
Issue Number: 2  
Dated: January 2002

Archived

### 3.1 Application

3.1.1 This section applies in respect of all small vessels.

### 3.2 Strength

3.2.1 Structural strength shall be commensurate with the intended service of the small vessel, taking into account the maximum anticipated loads. A non-pleasure craft may meet that requirement in different ways, including if it is in a good state of repair and either:

- (a) built in accordance with good boat building practices and construction standards recognized by the marine community; for example, for small vessels, Nordic Boat Standard (commercial vessels less than 15 m), International Organization for Standardization (ISO), American Bureau of Shipping (ABS), Lloyd's Register of Shipping (LRS), Bureau Veritas (BV), Det Norske Veritas (DNV), Germanischer Lloyd (GL); or
- (b) of a design with a record of at least 5 years history of safe operation, without any occurrence, in an area where the wind and wave conditions are no less severe than those likely to be encountered in the intended area of operation.

3.2.2 Proper alignment and continuity of structural members and efficiency of structural connections and endings shall be ensured. All openings and cutouts shall have well-rounded corners and not impair the required structural strength of the hull and superstructure.

3.2.3 Seats, thwarts, bulkheads, and other major structural components that are attached to the shell of the vessel shall be robustly connected in a manner that does not create stress concentrations.

3.2.4 Materials subjected to stress at high or low temperatures shall have properties resistant to failure at the full range of anticipated temperatures.

### 3.3 Fittings and Through-hull Openings

3.3.1 All openings and penetrations in structures shall:

- (a) if the small vessel is a non-pleasure craft, the keel of which was laid or the construction or manufacture or fibreglass lay-up of which was started on or after April 1, 2005, will provide a degree of water tightness in accordance with ISO 12216;
- (b) be kept to a minimum; and
- (c) be fitted with reliable means of closure.

3.3.1.1 Every closure shall be of a strength and design to maintain watertight integrity.

- 3.3.2 Through-hull penetrations shall:
- (a) be kept to a minimum;
  - (b) be consistent with the operational needs of the small vessel; and
  - (c) have adequate local strength compensation equivalent to the unpierced structure in which it is located and be of such construction that it will maintain watertight integrity.
- 3.3.2.1 Means shall be provided for positively shutting off underwater penetrations (except for wet exhaust systems) and, where fitted in a fire risk area, the means of shut-off shall be of material that is not susceptible to fire damage.
- 3.3.3 Local stiffening and reinforcement shall be provided for of deck-mounted machinery, equipment, fairleads, masts, mooring cleats, towing bollards, and other miscellaneous fittings. Such stiffening and reinforcement shall take into account the maximum anticipated deck loading.

### 3.4 Doors, Hatches, Windows, and Port Lights

- 3.4.1 The closing appliances such as exterior doors, hatches, windows and port lights shall be of marine construction, using good boat building practices, with reliable means of securing them while underway. Hinged doors and hatches shall open outward and generally be hinged on the forward or outboard side. The required degree of water tightness of closures shall be appropriate for their location on the small vessel and the operational exposure of the small vessel to the environmental conditions. If the small vessel is a non-pleasure craft, the keel of which was laid or the construction or the manufacture or fibreglass lay-up of which was started on or after April 1, 2005, the required degree of water tightness of closures shall be in accordance with the provisions of ISO 12216.
- 3.4.2 Windows, port lights, and skylights shall be fitted with safety glass or equivalent material of equal strength. Where a non-pleasure craft is intended to operate more than 20 nautical miles from shore, windows, port lights, and skylights shall be mechanically fastened in place in accordance with the manufacturers instructions.

### 3.5 Ballast

- 3.5.1 When provided, ballast shall be secured to prevent movement during vessel operations.

## 3.6 Personal Watercraft

### 3.6.1 Alternative Construction Standards

- 3.6.1.1 Every personal watercraft constructed or manufactured on or after January 1, 1997, may, as an alternative to other sections of this Standard, be constructed or manufactured in accordance with ISO 13590 *Small Craft – Personal Watercraft*.
- 3.6.1.2 Every new personal watercraft constructed or manufactured on or after January 1, 1997, shall have a Conformity Label in accordance with subsection 2.3.2.

### 3.6.2 Warning Label for the Ventilation of the Engine Compartment

- 3.6.2.1 All personal watercraft built on or after January 1, 1997, shall carry a prominently displayed warning label, which may be included with other information, that states that the seat or lid is to be opened to minimize the risk of fire and explosion. The Warning Label described shall include the information as shown in Figure 3-1.

**Figure 3-1 Personal Watercraft Warning Label**

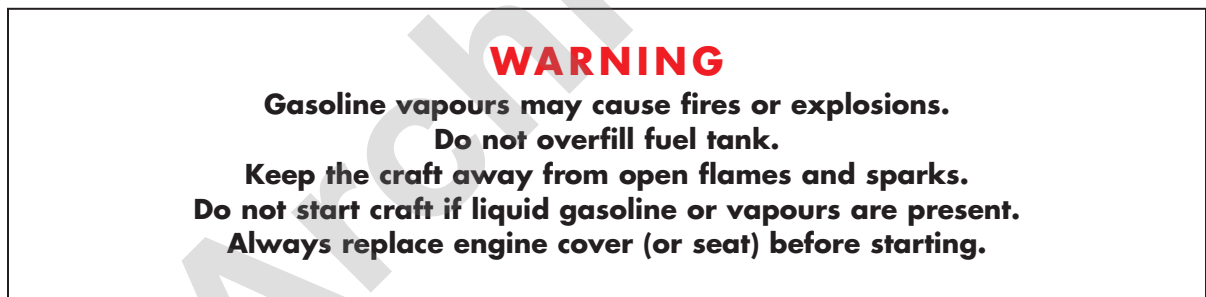

## 3.7 Navigation Lights

- 3.7.1 The *Collision Regulations* under the *Canada Shipping Act* apply in respect of navigation lights.

## 3.8 Precautions against fall

### 3.8.1 Application

- 3.8.1.1 This section applies in respect of non-pleasure craft only.

### 3.8.2 Bulwarks, Guardrails, Stanchions, etc.

- 3.8.2.1 Where practicable, the perimeter of an exposed deck that is intended to be used by persons on board shall be fitted with bulwarks, guardrails, stanchions, and netting, or any combination thereof, to protect any person from falling overboard while the vessel is underway.
- 3.8.2.2 Non-skid surfaces shall be used in working and traffic areas to minimize the possibility of any person slipping.
- 3.8.2.3 Grab rails shall be provided to assist movement of any persons on board.
- 3.8.2.4 On passenger vessels, the bulwarks, guardrails, stanchions and netting, or any combination thereof, shall be at least 915 mm (3 ft) above the weatherdeck. The distance between the horizontal rails shall not be more than 230 mm (9 in), unless netting of a strength preventing a person from falling overboard is provided. When application of such measures would impede the working of the vessel, equivalent safety measures shall be considered.
- 3.8.2.5 There shall be provisions to prevent children from falling overboard when the vessel's intended use includes carrying children.

## 3.9 Guard Rails and Grab Rails

### 3.9.1 Application

- 3.9.1.1 This section applies to pleasure craft only.
- 3.9.2 All pleasure craft shall comply with ABYC *Standards for Small Craft* H41.6

## 3.10 Pollution Discharge Advisory

- 3.10.1 Manufacturers, builders, importers and owners of small vessels note:

*Pleasure Craft Sewage Pollution Prevention Regulations*, the *Non Pleasure Craft Sewage Pollution Prevention Regulations* and Provincial Regulations apply with respect to the discharge of sewage.

**Note:** Refer to Appendix 3 of TP1332 for illustrations of typical sewage systems arrangements.

**Section 4.0**

**HULL DESIGN REQUIREMENTS**

**ISSUE NUMBER: 3**

**DATE: 2004 Edition**

**NUMBER OF PAGES: 21**

THIS ISSUE SUPERSEDES

Issue Number: 2

Dated: January 2002

Archived

## 4.1 Application

4.1.1 This section applies in respect of all small vessels that are not over 6 m (19 ft 8 in) in length.

## 4.2 Monohull Vessels

### 4.2.1 General

4.2.1.1 Scuppers, freeing ports, drains, overboard discharge, and centreboard trunk openings may be located below the static float plane (SFP). Other openings are permitted below the SFP in the motor well for outboard engine controls or fuel lines. All openings below the SFP shall be provided with a boot or other means to minimize leakage.

4.2.1.2 For information on taking measurements of monohull vessels, see Appendix 1, part A1.5.

### 4.2.2 Motor Well

4.2.2.1 A motor well is acceptable if:

- (a) it tends to reverse the flow of any water striking the forward face of the well rather than directing it upward and forward;
- (b) it has control or other openings of minimum size for safe operation that are located as high as possible and not lower than the normal motor cutout in the transom, unless fitted with sealing devices to prevent flooding through the openings; and
- (c) it has drains fitted that will allow the complete drainage of water within a maximum of five (5) minutes.

### 4.2.3 Recommended Maximum Load Calculation (Intact Condition)

4.2.3.1 Where an outboard power-driven small vessel is of monohull construction, the recommended maximum load in kilograms shall be determined as follows:

$$GL = \frac{(D_{SFP} - W_v)}{5} - W_e$$

Where;

GL = gross load in kilograms

$W_v$  = vessel weight in kilograms

$W_e$  = engine weight in kilograms, as determined from Table 4-1

$D_{SFP}$  = displacement to static float plane (kg) as calculated by the following formula:

$$D_{SFP} = (V_{tot} - V_{mw}) \times 1000$$

Where

$V_{tot}$  = total volume in cubic metres (m<sup>3</sup>), representing the internal volume of the vessel below the static float plane as determined by Figure 4–1, including the volume of the integral structure aft of the transom below the static float plane, and excluding the volume of the integral chambers that flood automatically.

$V_{mw}$  = motor well volume in cubic metres (m<sup>3</sup>),

1000 = the factor representing a weight in kilograms of 1.0 m<sup>3</sup> of fresh water

#### 4.2.4 The Recommended Maximum Number of Persons

4.2.4.1 The recommended maximum number of persons shall not exceed:

- (a) the number of designated occupant positions; and
- (b) the live load redistributed, as required, for the stability test (subsection 4.2.8.5 and 4.2.8.6).

4.2.4.2 The recommended number of persons must not be greater than the recommended maximum load divided by 75 kg (165 lbs), the assumed weight of one adult person.

#### 4.2.5 Recommended Maximum Power Calculation

4.2.5.1 This subsection is divided into two categories:

- (A) for manufacturers, constructors, and importers of monohull small vessels; and
- (B) for monohull pleasure craft owners and monohull second hand pleasure craft brokers using the short method to calculate the recommended maximum power.

##### (A) Power calculation for manufacturers, constructors, and importers of monohull small vessels

4.2.5.2 Where an outboard power-driven small vessel is of monohull construction and not exceeding 6 m in length, the maximum recommended power in kilowatts shall be determined in relation to the overall length of the vessel ( $L_h$ ) and maximum transom width ( $D_h$ ), excluding handles and extensions, but including permanently installed rub-rails. The formula to apply is determined by whether  $f$  (factor) =  $L_h \times D_h$  is greater or less than 5.1, the midship deadrise angle, and the type of steering.

$$f = L_h \times D_h$$

Alternatively, calculate the factor ( $f$ ) and interpolate the recommended maximum power from the appropriate curve in Figure 4–2 based on the midship deadrise angle and type of steering.

Figure 4-1 Length and Width Definitions for Load Calculations

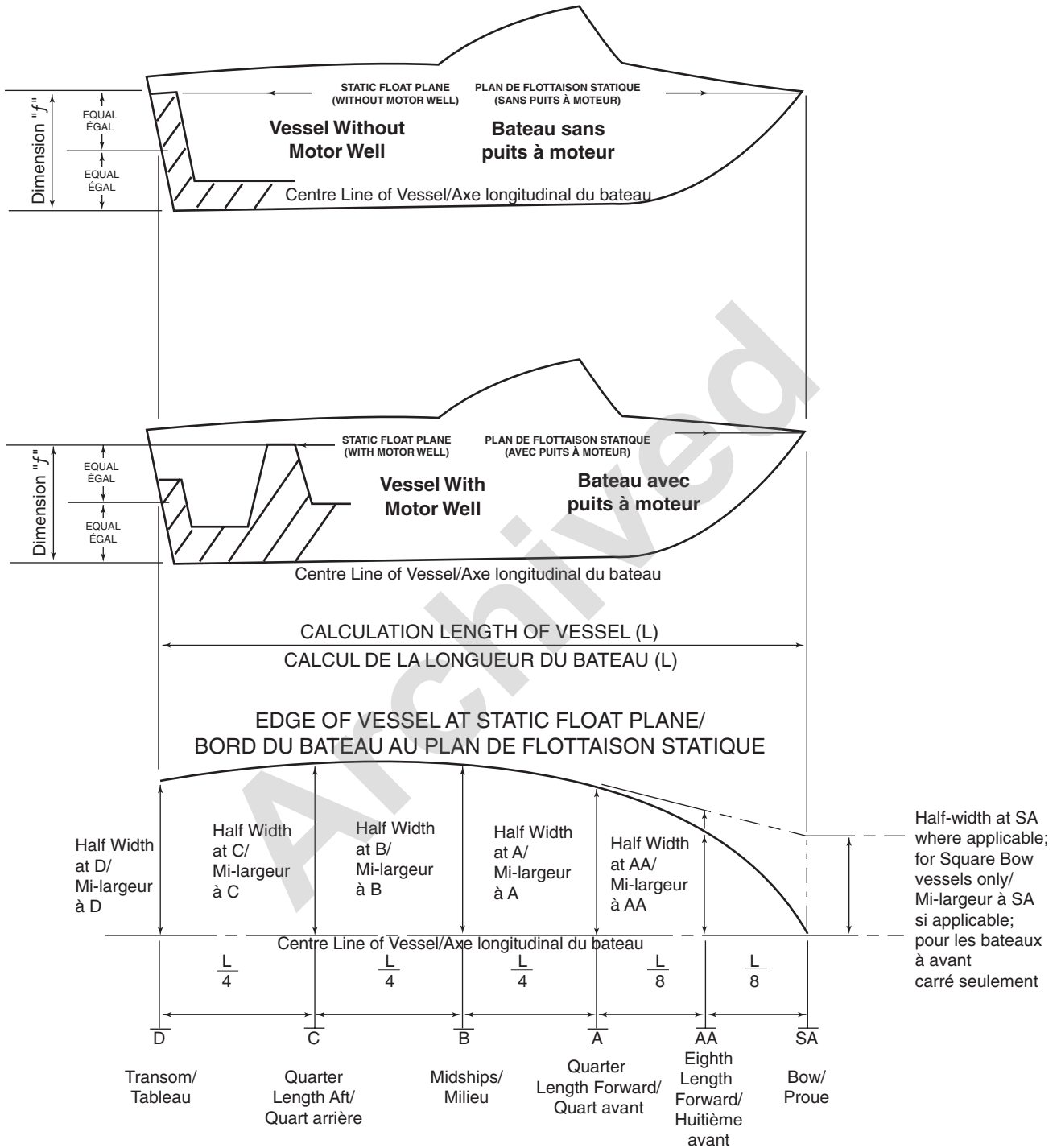

**Figure 4-2 Graph Used by Manufacturers, Constructors and Importers to Interpolate the Recommended Maximum Power of Small Vessels of Monohull Construction**

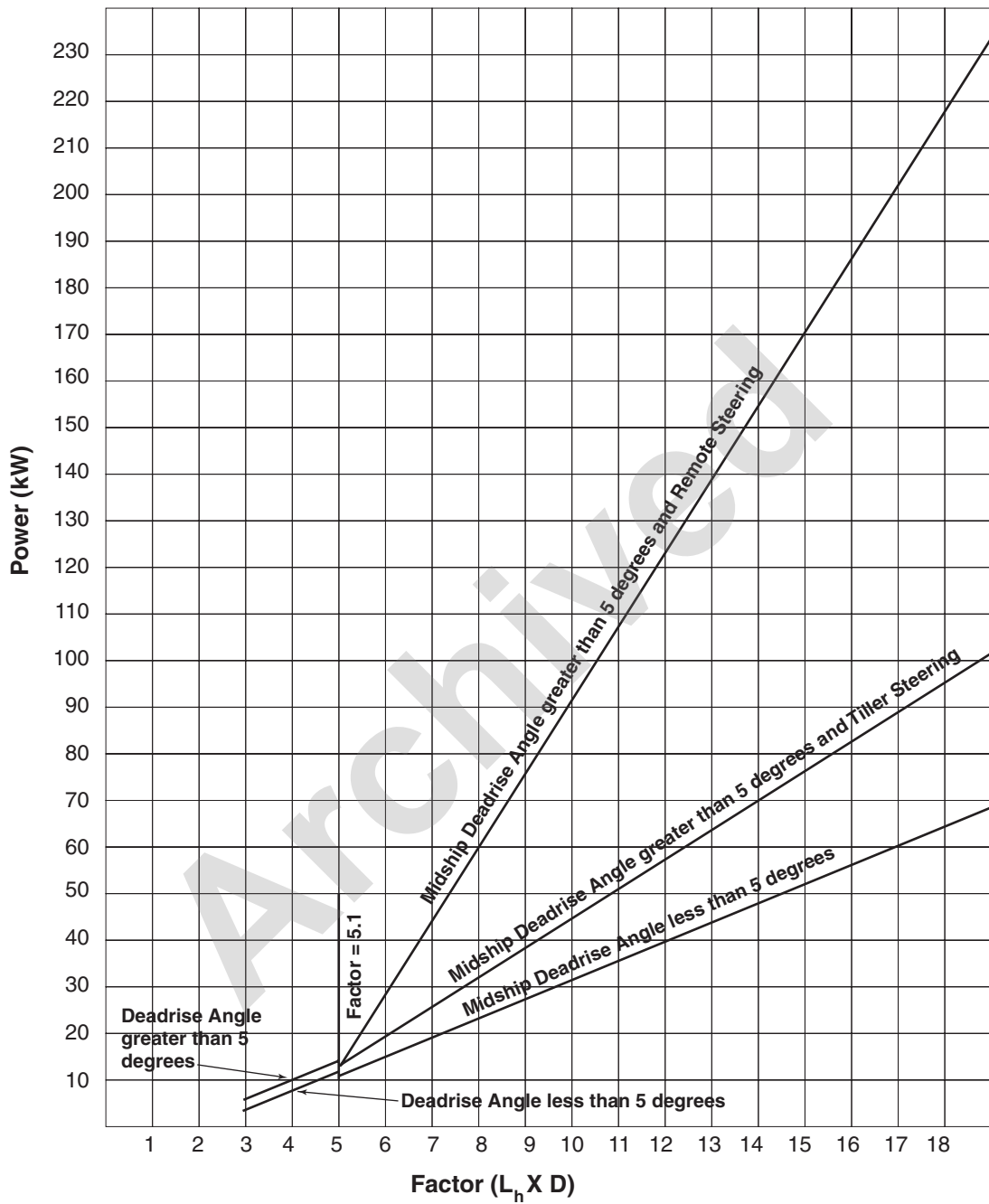

**Table 4-1 Weights (in kilograms) of Gasoline Outboard Engines and Related Equipment for Various Kilowatt Ratings**

1	2	3	4	5	6	7
Vessel Kilowatt Rating (KW)	Dry Weight + Fluids + Heaviest Propeller (Kg)	Controls (Kg)	Remote Oil Tank (Kg)	*Dry Battery Weight (Kg)	Full Portable Fuel Tank (Kg)	Total Weight (Kg)
<b>SINGLE ENGINE INSTALLATIONS</b>						
0.0 – 1.5	13.7	0.0	0.0	0.0	0.0	13.7
1.6 – 2.9	18.2	0.0	0.0	0.0	0.0	18.2
3.0 – 5.2	40.9	0.0	0.0	0.0	11.4	52.3
5.3 – 11.2	60.0	0.0	0.0	9.1	22.7	91.8
11.3 – 18.7	104.5	0.0	0.0	20.5	22.7	147.7
18.8 – 33.6	119.5	4.6	0.0	20.5	45.4	190.0
33.7 – 44.8	157.1	4.6	0.0	20.5	45.4	227.6
44.9 – 56.0	183.9	4.6	0.0	20.5	45.4	254.4
56.1 – 74.6	203.0	4.6	0.0	20.5	45.4	273.5
74.7 – 108.2	242.0	4.6	11.4	20.5	45.4	323.9
108.3 – 164.1	256.1	4.6	11.4	20.5	45.4	338.0
164.2 and up	282.9	4.6	11.4	20.5	45.4	364.8
Vessel Kilowatt Rating (KW)	Dry Weight+ Fluids + Heaviest Propeller (Kg)	Controls (Kg)	Remote Oil Tank (Kg)	*Dry Battery Weight (Kg)	Full Portable Fuel Tank (Kg)	Total Weight (Kg)
<b>TWIN ENGINE INSTALLATIONS</b>						
37.6 – 67.2	238.8	9.1	0.0	40.9	45.4	334.3
67.3 – 89.6	314.2	9.1	0.0	40.9	45.4	409.6
89.7 – 112.0	367.7	9.1	0.0	40.9	45.4	463.2
112.1 – 149.2	405.9	9.1	0.0	40.9	45.4	501.3
149.3 – 216.4	484.0	9.1	22.7	40.9	45.4	602.1
216.5 – 328.2	512.1	9.1	22.7	40.9	45.4	630.3
328.3 and up	565.7	9.1	22.7	40.9	45.4	683.8

\*The total weights provided in table 4-1 includes the weight of one battery per engine.

4.2.5.2.1 If the factor is less than 5.1 ( $f < 5.1$ ), use the following formulas to obtain the recommended maximum power in kilowatts (kW) or horsepower (hp):

- (a) midship deadrise angle less than 5 degrees (minimum factor  $f = 3.6$ )

$$\text{Maximum Power (kW)} = 5.82 \times f - 18$$

$$\text{Maximum Power (hp)} = (5.82 \times f - 18) / 0.745$$

- (b) midship deadrise angle greater than or equal to 5 degrees (minimum factor  $f = 3.0$ )

$$\text{Maximum Power (kW)} = 5.5 \times f - 13$$

$$\text{Maximum Power (hp)} = (5.5 \times f - 13) / 0.745$$

4.2.5.2.2 If the factor is equal to or greater than 5.1 ( $f \geq 5.1$ ), use the following formulas to obtain the power in kilowatts (kW) or horsepower (hp):

- (a) midship deadrise angle less than 5 degrees, remote and tiller steering

$$\text{Maximum Power (kW)} = 4.2 \times f - 11$$

$$\text{Maximum Power (hp)} = (4.2 \times f - 11) / 0.745$$

- (b) midship deadrise angle greater than or equal to 5 degrees, tiller steering

$$\text{Maximum Power (kW)} = 6.4 \times f - 19$$

$$\text{Maximum Power (hp)} = (6.4 \times f - 19) / 0.745$$

- (c) midship deadrise angle greater than or equal to 5 degrees, remote steering

$$\text{Maximum Power (kW)} = 16 \times f - 67$$

$$\text{Maximum Power (hp)} = (16 \times f - 67) / 0.745$$

**(B) Power calculation for monohull pleasure craft owners and second-hand monohull pleasure craft brokers**

4.2.5.3 Where an outboard power-driven, second-hand pleasure craft is of monohull construction and is not over 6 m, the maximum recommended power in kilowatts shall be determined by obtaining a value, Numeral, in relation to the gross load (GL) and maximum transom width ( $D_h$ ), and applying that Numeral to the appropriate curve in Figure 4-3.

$$\text{Numeral (N)} = \frac{\text{GL} \times D_h}{1.382}$$

Where

Numeral = the calculated value used to interpolate power in kilowatts from Figure 4–3 or to calculate power in equations 4.2.5.3.1 (a), (b), and (c).

GL = gross load in kilograms

$D_h$  = maximum transom width in metres

**Figure 4–3 Graph Used by Owners of Pleasure Craft of Monohull Construction and Brokers of Second-hand Pleasure Craft of Monohull Construction to Interpolate the Recommended Maximum Power**

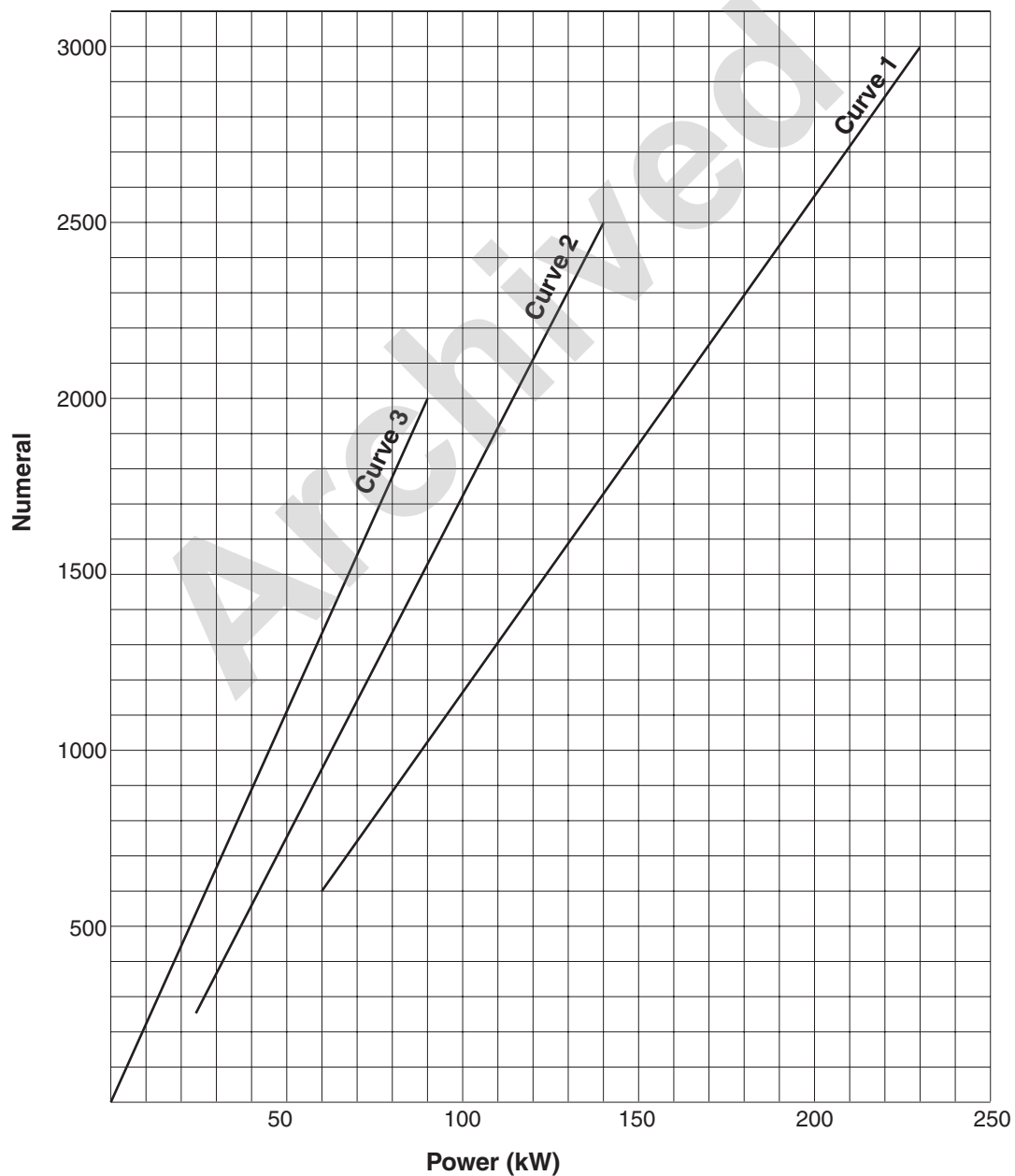

4.2.5.3.1 As an alternative to using Figure 4–3, calculate the Numeral as indicated in 4.2.5.3 and apply this value to the appropriate formula listed below, determined by the Numeral value, overall vessel length, maximum transom width, midship deadrise angle, and type of steering.

(a) The following formulas apply for maximum power (Curve 1):

$$\text{Maximum Power (kW)} = (0.071 \times \text{Numeral}) + 18$$

$$\text{Maximum Power (hp)} = [(0.071 \times \text{Numeral}) + 18] / 0.745$$

if the pleasure craft meets all the following conditions:

- (i) its numeral is equal to or exceeds 600 ( $N \geq 600$ );
- (ii) the length of vessel is greater than or equal to 4.75 m and it does not exceed 6 m ( $4.75 \leq L_h \leq 6$  m);
- (iii) its transom width is greater than or equal to 1.22 m ( $D_h \geq 1.22$  m);
- (iv) its midship deadrise angle is greater than 5 degrees (no flat bottom vessels);
- (v) the pleasure craft is fitted with remote steering.

(b) The following formulas apply for maximum power (Curve 2):

$$\text{Maximum Power (kW)} = (0.056 \times \text{Numeral}) + 11$$

$$\text{Maximum Power (hp)} = [(0.056 \times \text{Numeral}) + 11] / 0.745$$

if the pleasure craft meets all the following conditions:

- (i) its numeral is greater than or equal to 250, but less than 600 ( $250 \leq N < 600$ ),
- (ii)  $D_h$  is greater than or equal to 1.14 m but less than 1.22 m ( $1.14 \text{ m} \leq D_h < 1.22$ ),
- (iii) its midship deadrise angle is greater than 5 degrees (no flat bottom vessels),
- (iv) the pleasure craft is fitted with remote steering.

(c) The following formulas apply for maximum power (Curve 3)

$$\text{Maximum Power (kW)} = 0.04 \times \text{Numeral}$$

$$\text{Maximum Power (hp)} = (0.04 \times \text{Numeral}) / 0.745$$

for pleasure craft not represented by (a) or (b)

#### **4.2.6 Power Rating Restriction (Racing Hydroplanes)**

4.2.6.1 Racing hydroplanes and similar low-volume racing craft are rated to a maximum of 7.4 kW (9.9 hp). This type of craft may use engine power greater than 7.4 kW (9.9 hp) only when engaged in, or in preparation for, an official competition.

#### **4.2.7 Minimum Flotation Test (Swamped Condition)**

##### **4.2.7.1 Application**

4.2.7.1.1 This subsection applies to all power-driven small vessels not over 6 m (19 ft 8 in) in length that are subject to swamping.

4.2.7.1.2 This subsection does not apply to the following:

- (a) small vessels powered by outboard engines, which are required to meet the criteria of the level flotation and stability standard in subsection 4.2.8; or
- (b) personal watercraft.

4.2.7.1.3 The method set out in subsection 4.2.7.3 or physical testing may be used to determine compliance with the relevant flotation criteria.

##### **4.2.7.2 Requirements for Minimum Flotation Test**

4.2.7.2.1 Every small vessel shall be fitted with inherently buoyant flotation material that provides sufficient buoyancy to keep the vessel from sinking when it is swamped and when the passengers are clinging to the outside of the vessel, where the individual weights of the motor, the passengers, and the equipment carried in or attached to the vessel do not exceed the weights used in the formula set out in paragraph 4.2.7.3.2.

4.2.7.2.2 The buoyancy required shall not be provided by air chambers greater than 0.014 m<sup>3</sup> (0.5 ft<sup>3</sup>) in volume or by any air chambers that are integral with the hull structure.

4.2.7.2.3 The quantity of flotation material required for a small vessel to meet the requirements of paragraph 4.2.7.2.1 shall be calculated using the formula set out in paragraph 4.2.7.3.2.

4.2.7.2.4 Flotation material shall be placed or secured so that it cannot be accidentally moved or floated out of place.

4.2.7.2.5 Flotation material shall be protected, as far as practicable, from mechanical damage.

**Table 4-2 Factors for Converting Various Small Vessel Material from Dry Weight to Submerged Weight**

Materials	Specific Gravity	Factor (k)
Lead	11.38	0.91
Copper	8.91	0.89
Monel Metal	8.91	0.89
Bronze	8.88	0.89
Nickel	8.61	0.88
Brass	8.56	0.88
Stainless Steel (rolled)	8.00	0.88
Steel	7.85	0.88
Cast Iron	7.08	0.86
Zinc-Cast Alloy	6.63	0.85
Aluminum	2.73	0.63
Glass	2.60	0.62
Ferro-Cement	2.40	0.58
Rubber	1.51	0.34
Fibreglass-Laminate	1.50	0.33
Kevlar-Laminate	1.30	0.24
Plexiglass-Lucite	1.20	0.17
A.B.S.	1.12	0.11
Teak	0.99	- 0.01
Oak-White	0.85	- 0.18
Oil-Diesel	0.85	- 0.18
Gasoline	0.73	- 0.37
Oak-Red	0.63	- 0.56
Blandex-Particle Board	0.58	- 0.70
Mahogany-Philippine	0.58	- 0.72
Mahogany-Honduras	0.56	- 0.78
Ash	0.56	- 0.78
Yellow Pine	0.55	- 0.81
Fir Plywood	0.55	- 0.81
Mahogany-Plywood	0.54	- 0.83
Royalex	0.50	- 0.95
Mahogany-African	0.51	- 0.96
Fir	0.51	- 0.96
Cedar-Port Orford	0.48	- 1.08
Spruce	0.45	- 1.22
Pine-White	0.42	- 1.38
Cedar-White	0.33	- 1.95
Cork	0.24	- 3.17
Balsa	0.16	- 5.24

**Notes on Table 4-2**

- Factor (k) = [Specific Gravity - 1] / Specific Gravity
- Specific Gravity of fresh water at 4°C = 1

### 4.2.7.3 Formulas for Minimum Flotation Test

4.2.7.3.1 To determine the volume of buoyant material required, the swamped weight of the vessel must first be calculated (see 4.2.7.3.2). This value is then used to find the amount of flotation required (see 4.2.7.3.3). The amount of flotation is in turn used in the formula to determine the volume of buoyant material required (see 4.2.7.3.4).

4.2.7.3.2 The swamped weight ( $W_s$ ) of the vessel and permanently installed fittings, excluding the engine and engine related equipment, shall be determined as follows:

$$W_s = \sum Whk + W_d + 0.69W_f$$

Where

$W_s$  = Swamped weight in kilograms of vessel and fittings other than engine and engine related equipment

$$\sum Whk = Wh_1k_1 + Wh_2k_2 + Wh_3k_3 \dots$$

$Wh_1, Wh_2, Wh_3 \dots$  = the dry weight in kilograms of various materials used in hull construction;

$k_1, k_2, k_3 \dots$  = a conversion factor applied to the weight of each piece of hull material ( $W_h$ ), to convert the dry material (h) to an equivalent weight when submerged in fresh water as determined by Table 4-2

$W_d$  = weight of deck and superstructure in kilograms

$W_f$  = weight in kilograms of permanent fittings not included in  $W_d$ .

4.2.7.3.3 The amount of flotation required ( $W_{fl}$ ) is determined by the following formula:

$$W_{fl} = W_s + 0.75 W_e + 0.25 W_l$$

Where

$W_s$  = swamped weight of the vessel in kilograms

$W_e$  = dry weight of the engine and related equipment in kilograms as installed

$W_l$  = the maximum load in kilograms, less the weight of the installed engine and related parts

4.2.7.3.4 The volume of buoyant material ( $V_b$ ) required in cubic metres shall be determined as follows:

$$V_b = \frac{W_{fl}}{1000 - W_b}$$

Where

$W_b$  = weight in kilograms of 1 m<sup>3</sup> of buoyant material used

$W_{fl}$  = as calculated in 4.2.7.3.3

#### **4.2.7.4 Flotation Material**

4.2.7.4.1 Flotation material, when used in the bilge or engine room bilge, shall not change volume by more than 5% after being immersed, for a period of time as set out in 4.2.7.4.2 and 4.2.7.4.3, at 29°C in each of the following liquids:

- (a) reference fuel B, in accordance with American Society of Testing and Materials ASTM D471;
- (b) No. 2 reference oil, in accordance with American Society of Testing and Materials ASTM D471; and
- (c) a 5% solution of trisodium phosphate in water.

4.2.7.4.2 The immersion time for flotation material used in the bilge shall be 24 hours.

4.2.7.4.3 The immersion time for flotation material used in the engine room bilge shall be 30 days.

4.2.7.4.4 Flotation material, when used in an engine room that is not open to the atmosphere, shall not reduce in volume by more than 5% after being immersed in a fully saturated gasoline vapour atmosphere for 30 days at 38°C.

4.2.7.4.5 The requirements of this subsection do not apply to flotation material used in a sealed compartment.

#### **4.2.8 Level Flotation and Stability Tests (Swamped Condition)**

##### **4.2.8.1 Application**

4.2.8.1.1 This subsection applies to all outboard power-driven small vessels not over 6 m (19 ft 8 in) in length, except small vessels not subject to swamping, sailboats, canoes, kayaks, inflatable crafts, amphibious craft, and vessels designed for racing.

4.2.8.1.2 Inboard and inboard-outboard small vessels are required to meet the standards of subsection 4.2.7 and are not included in this subsection.

4.2.8.1.3 Numerical methods or physical testing may be used to determine compliance with the relevant flotation criteria.

##### **4.2.8.2 Preconditioning for Level Flotation Test**

4.2.8.2.1 Every permanently installed fitting supplied by the manufacturer or constructor, such as windshields and convertible tops, shall be secured in place.

- 4.2.8.2.2 The vessel shall be loaded with weights that, when submerged, are equivalent to the weight of the following:
- (a) 50% of the live load of the vessel as defined in paragraph 1.2.1, up to 250 kg (550 lbs) and, if the live load exceeds 250 kg (550 lbs), 12% of the excess;
  - (b) 25% of the difference between maximum load and live load after deducting the weight of the engine, battery, and full fuel tank from the maximum load; and
  - (c) the engine, battery, and fuel.
- 4.2.8.2.3 The weights in 4.2.8.2.2 (a) and (b) shall be placed so that their centre of gravity lies at the centre of the person-carrying area, but they shall all be contained within 16% of the person-carrying areas, as shown in Figure 4-5.
- 4.2.8.2.4 The weights in 4.2.8.2.2 (c) shall be placed as close as practicable to the position of those components they replace.
- 4.2.8.2.5 Permanent fuel tanks shall be filled with fuel and sealed.
- 4.2.8.2.6 Water and holding tanks shall be filled with fresh water.
- 4.2.8.2.7 For the purpose of physical testing, the vessel shall be swamped for a period of not less than 18 hours so that all compartments integral with the hull are flooded, no trapped air remains in the hull, and water is free to flow in and out of the hull.
- 4.2.8.2.8 Where air chambers are part of the flotation, the two largest shall be perforated so as to allow complete flooding.

### **4.2.8.3 Person-Carrying Area**

- 4.2.8.3.1 The person carrying area is the area of a small vessel in which people may assume a safe sitting or standing position while the vessel is in operation.
- 4.2.8.3.2 The length of the person-carrying area is the distance along the centre line of the vessel between two assumed vertical lines, one forward and one aft of the area, when the vessel is on an even keel. For small vessels with a curved stem inside the person-carrying area, the forward vertical line intersects the stem at a point where a line drawn at 45 degrees to the horizontal is tangential to the stem. For small vessels with enclosed cabins, the forward vertical line is perpendicular to the centre line at the forward limit of that area where there is 0.6 m (2 ft) of headroom between the inside of the cabin top and the swamped waterline (see Figure 4-4).
- 4.2.8.3.3 The breadth of each person-carrying area is the distance between two assumed vertical lines at mid-length, excluding consoles, of the person-carrying area when the small vessel is upright (see Figure 4-4). For small vessels with round chines, the vertical lines intersect the hull on each side at a point where lines drawn at 45 degrees to the horizontal are tangential to the hull on either side.

**Figure 4-4 Criteria for Measuring the Length of Person-carrying Area**

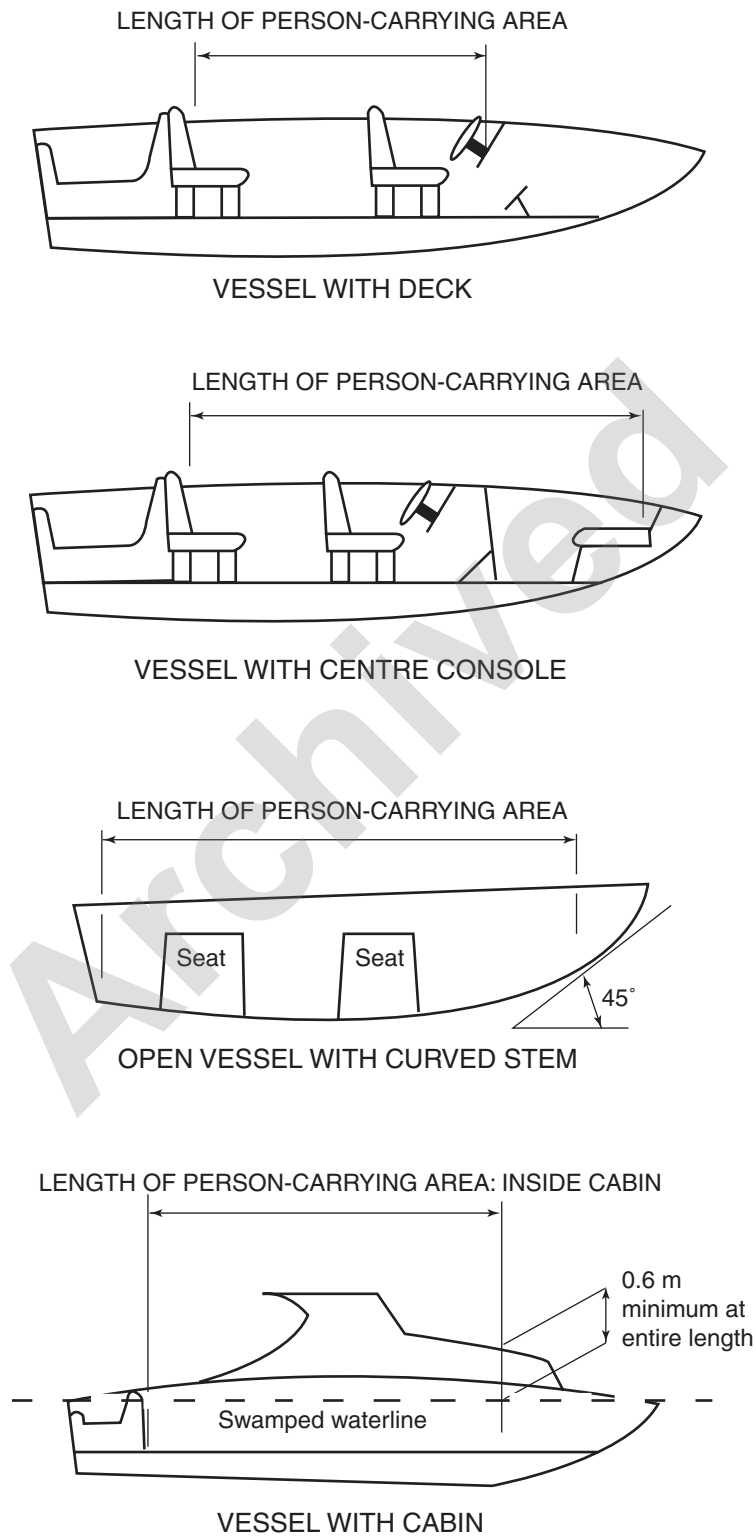

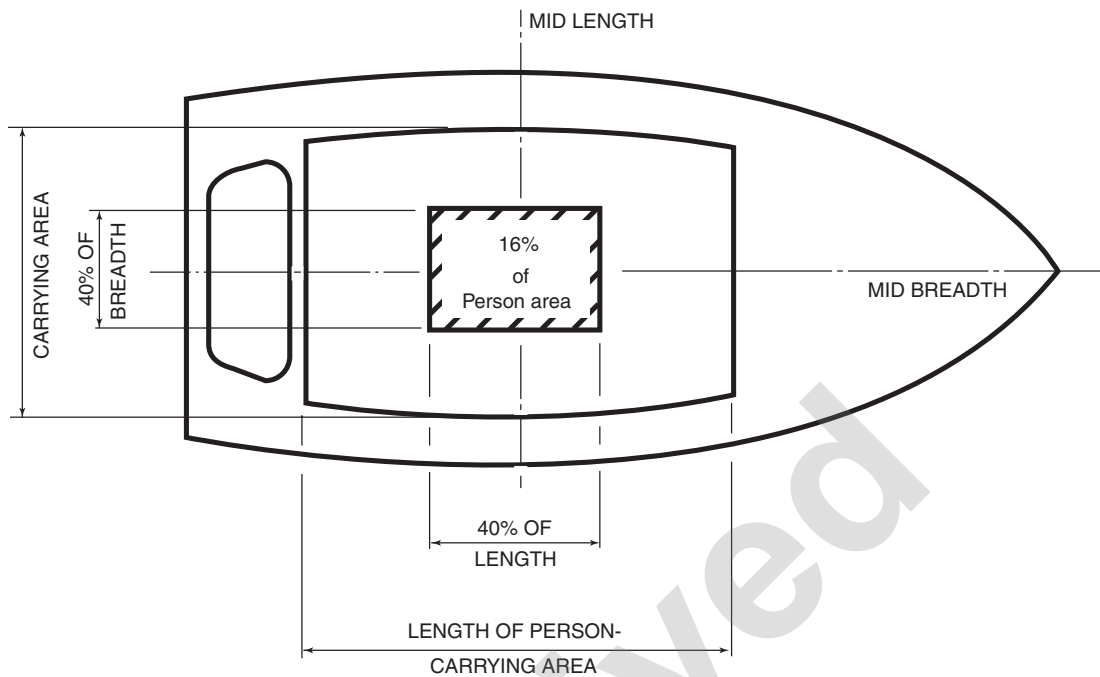
**Figure 4-5 Location of Centre of Gravity of Weights (level Flotation)**

#### 4.2.8.4 Requirements for Level Flotation Test

4.2.8.4.1 When the specified preconditioning has been completed (subsection 4.2.8.2), the small vessel shall float in fresh water as follows:

- (a) the angle of heel shall not exceed 10 degrees;
- (b) one part of either the bow or stern reference areas, as defined in paragraph 1.2.1, shall remain above the surface of the water; and
- (c) the midpoint of the submerged bow or stern reference area shall not be more than 152 mm (6 in) below the surface of the water.

#### 4.2.8.5 Preconditioning for Stability Test

4.2.8.5.1 Preconditioning shall be completed as for the level flotation test, except for deployment of live load weights specified in paragraph 4.2.8.2.2, which shall be redistributed as follows:

- (a) half of the weight is to be removed from the small vessel, with the other half arranged on one side of the vessel so that the horizontal centre of gravity of the weights falls within 152 mm (6 in) of the outer edge of the person-carrying area for at least 70% of its length (Figure 4-6);

- (b) the vertical centre of gravity of the weights shall be at least 102 mm (4 in) above the cockpit floor, or if the weights are placed on seats, the vertical centre of gravity of the weights shall be at least 102 mm (4 in) above the seats.

#### 4.2.8.6 Requirements for Stability Test

- 4.2.8.6.1 While floating in calm water, the small vessel shall not list more than 30 degrees with the weight redistributed.
- 4.2.8.6.2 One part of either the bow or stern reference area, as defined in paragraph 1.2.1, shall remain above the surface.
- 4.2.8.6.3 The midpoint of the submerged bow or stern reference area shall be not more than 305 mm (12 in) below the surface.

**Figure 4-6 Location of Centre of Gravity of Weight (stability Test)**

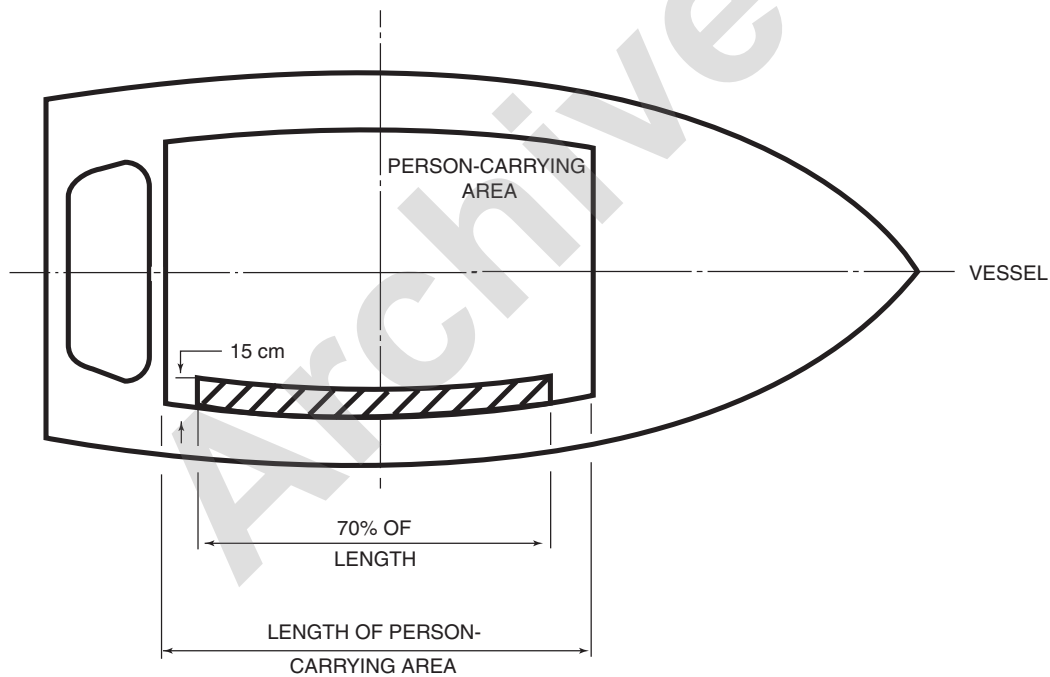

### 4.3 Multihull Small Vessels (Pontoon)

#### 4.3.1 Calculation Criteria (Intact Condition)

- 4.3.1.1 The criteria for developing the maximum recommended ratings are based on the flotation provided by the pontoons or multihulls. The following design conditions apply:
- (a) the multihull small vessel shall have only one deck;
  - (b) the deck shall not extend beyond the width of the pontoons;
  - (c) the deck length within railings defining person-carrying area shall not be more than 80% of the pontoon length and shall not overhang the pontoons;
  - (d) the deck shall be located no more than 152 mm (6 in) above the pontoons; and
  - (e) the deck shall drain freely.
- 4.3.1.2 Where the design of a multihull small vessel does not conform to the criteria in paragraph 4.3.1.1, the maximum load shall be determined by the stability tests in sections 4.3.1.3, 4.3.1.4 and 4.3.1.5, conducted with the maximum engine power which is intended for use with the small vessel and with full fuel tanks and operational equipment in the normal positions.
- 4.3.1.3 The transverse stability shall be tested by adding weights on the highest deck to one side as far outboard as is practicable within the limits of the design, until the top of the pontoon hull on the loaded side becomes awash.
- 4.3.1.4 The longitudinal stability shall be tested by adding weight on the highest deck evenly about a point in the longitudinal centre line of the vessel, one quarter of the length of the deck from forward, until the edge of the lower deck becomes immersed. This test shall be repeated at the aft end of the small vessel by adding weight evenly about a point one quarter of the length of the deck from aft until the edge of the lower deck or the top of the motor mounting bracket becomes immersed, whichever occurs first.
- 4.3.1.5 Ninety percent (90%) of the least of the weights attained in the tests above shall be the total weight of persons allowed on board the small vessel.
- 4.3.1.6 Where additional confirmation of a vessel's stability is required, based on the calculation and assessment of the surveyor or inspector, the following approach shall be used: *Alternative Standard for the Intact Stability of Small Passenger Vessels of Multiple Pontoon Configuration and Restricted Passenger Movement* (Appendix B to Stab 5 of the *Stability, Subdivision, and Load Line Standards* [TP7301]).

### 4.3.2 Recommended Maximum Load Calculation

4.3.2.1 Where a power-driven small vessel is of multihull construction and is not over 6 m (19 ft 8 in) in length, the maximum recommended load in kilograms is determined by the lesser of the following (a) or (b):

$$(a) \quad GL = \left( \frac{(V_t \times b) - W}{2} \right) - W_e$$

Where

GL = Gross Load

b = constant buoyancy factor of 1000 kg/m<sup>3</sup>

V<sub>t</sub> = the total volume in cubic metres within all of the pontoons of a vessel

W = the dry weight in kilograms of the vessel, deck, railings, console, seats, and any other permanent Structures and fittings, excluding the outboard engine or portable fuel tank

W<sub>e</sub> = outboard engine weight, as determined from Table 4-1

(b) Maximum load as defined in paragraph 4.3.1.6

### 4.3.3 The Recommended Number of Persons

4.3.3.1 Where a small vessel is of multihull construction and is not over 6 m (19 ft 8 in) in length, the recommended number of persons shall be determined in relation to the volume of pontoons, the volume of the largest compartment of the pontoon, gross load, and engine weight as follows:

$$\text{Number of Persons} = \frac{GL}{75} \times \left( 1 - \frac{V_{lc}}{V_p} \right)$$

Where

GL = gross load in kilograms

V<sub>lc</sub> = volume of largest compartment, in cubic metres, defined as the largest volume between separation bulkheads in any pontoon

V<sub>p</sub> = total volume in cubic meters of all pontoons

75 = assumed weight of one person in kilograms

#### 4.3.4 The Recommended Maximum Power

- 4.3.4.1 Where a small vessel is of multihull construction and is not over 6 m (19 ft 8 in) in length, the recommended maximum power in kilowatts shall be determined in relation to the squared length and the diameter of the pontoons as follows:

$$\text{Maximum Power (kW)} = 3 \times L^2 \times D_p$$

Where

L = length of the pontoon in metres

$D_p$  = diameter of the pontoon in metres

### 4.4 Small Vessels – Inflatable and Rigid Inflatable

#### 4.4.1 Calculation Criteria (Intact Condition)

- 4.4.1.1 The criteria for developing the maximum recommended ratings is based on the flotation provided by the inflated tubes, and in addition, where applicable, the volume of the hull below the cockpit sole.

#### 4.4.2 Recommended Maximum Load Calculation

- 4.4.2.1 Where a power-driven small vessel is of inflatable or rigid inflatable construction, that is not over 6 m (19 ft 8 in) in length, the recommended maximum load in kilograms shall be determined in relation to the total volume of inflatable tubes (V) and the dry weight of the vessel as follows:

$$GL = (V \times b \times 0.75) - W$$

Where

GL = gross load in kilograms

V = the total volume of the inflated tubes in cubic metres, and where appropriate, the volume of the rigid or inflated hull below the cockpit sole

b = constant buoyancy factor = 1000 kg/m<sup>3</sup>

W = dry weight of the vessel in kilograms

- 4.4.2.2 The following variances, dependent on design features, are applied to the recommended maximum load results calculated by 4.4.2.1. Load reduction for the minimum number of chambers in the collar is as follows:

- (a) 1 air chamber = 50% load reduction;
- (b) 2 air chambers = 33% load reduction;

- (c) 3 air chambers = 25% load reduction;
- (d) 4 air chambers = No load reduction.

#### 4.4.3 Recommended Maximum Number of Persons

4.4.3.1 Where a power-driven small vessel is of inflatable or rigid inflatable construction and is not over 6 m (19 ft 8 in) in length, the recommended maximum number of persons shall be determined in relation to gross load and engine weight in kilograms as follows:

$$\text{Number of People} = \frac{GL - W_e}{75}$$

Where

GL = gross load in kilograms

$W_e$  = engine weight in kilograms

75 = assumed weight of one person in kilograms

#### 4.4.4 The Recommended Maximum Power

4.4.4.1 Where a power-driven small vessel is of inflatable or rigid inflatable construction and is not over 6 m (19 ft 8 in) in length, the recommended maximum power shall be determined in relation to total vessel length, its beam, the total internal volume of the inflatable tubes and a design factor, as follows:

$$\text{Power (kW)} = \frac{L}{B} \times V \times f_x$$

Where

L = total length of the vessel in metres

V = total internal volume of the inflatable tubes in cubic metres

B = beam of the vessel in metres

$f_x$  = a constant factor determined by transom type as follows:

- (a) Factor ( $f_1$ ) for stern tube type (Bracket) = 2.5
- (b) Factor ( $f_2$ ) for stern transom type, vessel length not exceeding 3.0 m = 6.5

(c) Factor ( $f_3$ ) for stern transom type, vessel length greater than 3.0 m but not exceeding 5.0 m = 7.5

(d) Factor ( $f_4$ ) for stern transom type, vessel length greater than 5.0 m = 9.0

4.4.4.2 The following variances (Table 4–3) are applied to the recommended maximum power calculation in 4.4.4.1. Choose one of the factors from the calculation method in relation to the design features (small vessel length, stern type, type of steering and its location):

<b>Item</b>	<b>Calculation Method</b>
Stern – Tube Type	Inflatable Calculation (Factor $f_1$ )
Stern – Transom Type	Inflatable Calculation (Factor $f_2$ or $f_3$ or $f_4$ )
Steering – Aft of L/4 forward of Transom	Inflatable Calculation (Factor $f_2$ or $f_3$ or $f_4$ )
Steering – Fwd of L/4 forward of Transom	Inflatable Calculation (Factor $f_2$ or $f_3$ or $f_4$ ) X 1.25 for vessels over 3.0 m in length

**Section 5.0**

**HULL DESIGN REQUIREMENTS FOR NON-PLEASURE CRAFT  
EXCEEDING 6 METRES**

**ISSUE NUMBER: 3**  
**DATE: 2004 Edition**  
**NUMBER OF PAGES: 1**

THIS ISSUE SUPERSEDES  
Issue Number: 2  
Dated: January 2002

Archived

## 5.1 Application

- 5.1.1 This section applies to every non-pleasure craft (excluding multihulls, inflatable craft, vessels carrying cargo over 1000 kg, and vessels built or converted for towing, dredging or lifting) exceeding 6 m (19 ft 8 in) in length, the keel of which was laid or the construction or manufacture or fibreglass lay-up of which was started on or after April 1, 2005.

## 5.2 Stability

- 5.2.1 All power driven vessels shall meet the requirements of ISO 12217-1.

## 5.3 Drainage

- 5.3.1 When cockpits and recesses are to be designated either as “watertight” or as “quick-draining,” they shall comply with the requirements of ISO 11812.

Archived

**Section 6.0**

**V E N T I L A T I O N   S Y S T E M S**

**ISSUE NUMBER: 3**  
**DATE: 2004 Edition**  
**NUMBER OF PAGES: 5**

THIS ISSUE SUPERSEDES  
Issue Number: 2  
Dated: January 2002

Archived

## 6.1 Application

6.1.1 This section applies in respect of all small vessels.

## 6.2 General

6.2.1 Neither supply nor exhaust air ducts from engine spaces or engine exhaust outlets shall open into an accommodation space.

6.2.2 Electrical components installed in gasoline engine spaces, gasoline tank spaces, and any connecting spaces not open to the atmosphere shall be ignition protected in accordance with Section 8 of this Standard.

## 6.3 Gasoline Engine and Fuel Tank Space Ventilation

### 6.3.1 Application

6.3.1.1 This subsection applies to all vessels, regardless of length or accommodation that have gasoline engines for propulsion or other purposes.

### 6.3.2 Removal of Combustible Vapours

6.3.2.1 Combustible vapours shall be removed from closed engine and fuel tank spaces by means of a ventilation system.

6.3.2.2 Open engine or fuel tank spaces do not require a separate ventilation system if in compliance with subsection 6.3.3.

### 6.3.3 Open Spaces Vessel Construction

6.3.3.1 A separate ventilation system is not required if an engine or fuel tank space has the following (see Figure 6-1):

(a) at least 0.34 m<sup>2</sup> (3.5 ft<sup>2</sup>) of area exposed to the atmosphere per cubic metre (35 ft<sup>3</sup>) of net space volume; and

(b) no long or narrow unvented spaces in which a flame front might propagate.

6.3.3.2 The net space volume is the volume of the engine or fuel tank space plus the volume of connecting spaces, unless the connecting spaces either:

(a) connect to spaces already ventilated by ducting; or

(b) themselves qualify as open spaces.

- 6.3.3.3 Spaces connecting with spaces open to the atmosphere, which have interconnecting openings with an area equal to 2% or less of the separation bulkhead, shall not be considered as open spaces.
- 6.3.3.4 The volumes of adjacent spaces shall be included in the calculation of duct sizes if the collective area of the openings in the separation bulkheads exceeds 2% of the separation bulkhead area between these spaces.
- 6.3.3.5 The separation bulkhead area used for the calculations in paragraph 6.3.3.4 and 6.3.3.3 shall be calculated using a height that is the lesser of either the distance between the bottom and top of the bulkhead between the spaces, or 750 mm (30 in).
- 6.3.3.6 Long narrow spaces formed by side panels or accommodation decks shall have openings at both ends or along the sides in order to qualify as open spaces.

**Figure 6-1 Open Spaces Vessel Construction**

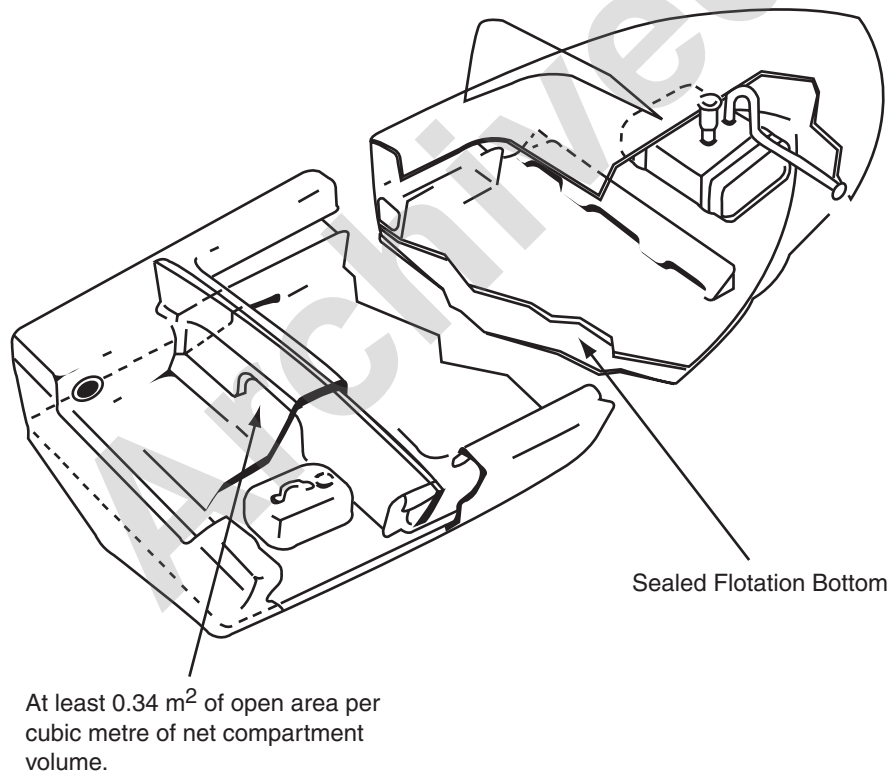

### 6.3.4 Closed Spaces Vessel Construction

- 6.3.4.1 A separate ventilation system is required if an engine or fuel tank space conforms to the following:
- the space has less than 0.34 m<sup>2</sup> (3.5 ft<sup>2</sup>) of area exposed to the atmosphere per cubic metre (35 ft<sup>3</sup>) of net space volume; or
  - does not otherwise meet the requirements for an open space.

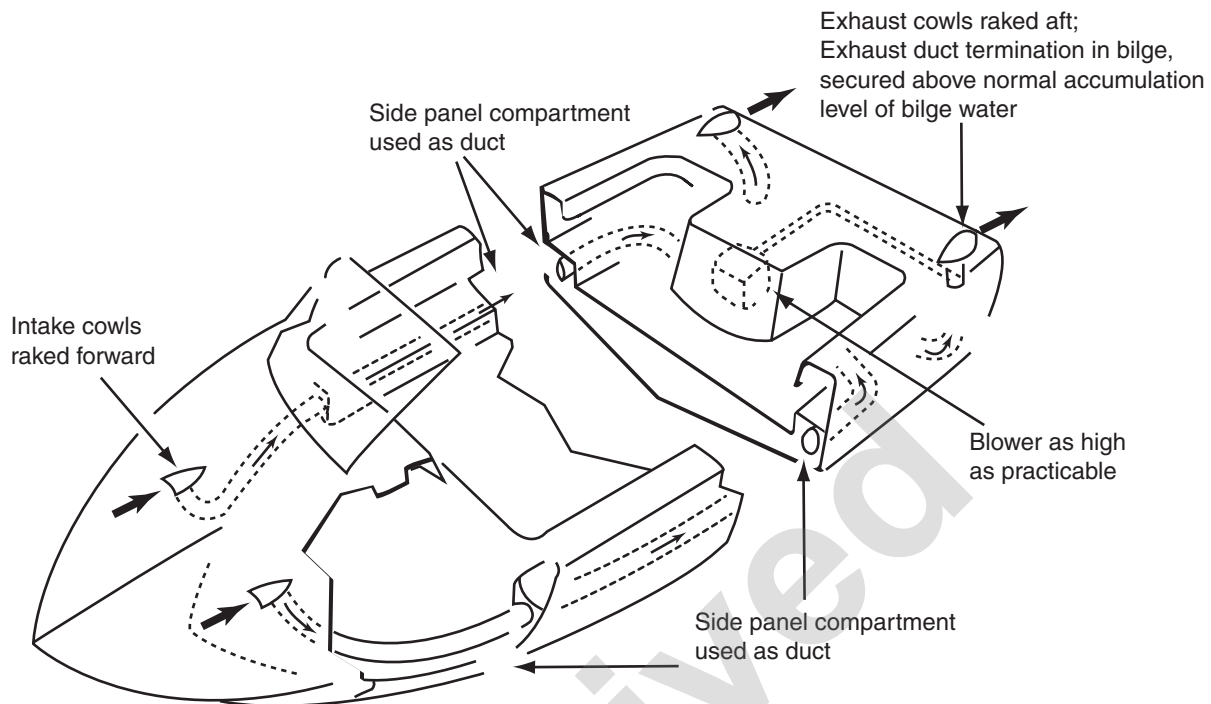
**Figure 6-2 Closed Spaces Vessel Construction**

### 6.3.5 Underway Ventilation

- 6.3.5.1 Every closed engine space and every closed space containing a permanent or portable fuel tank shall be provided with a ventilation system designed to remove any accumulation of combustible vapours.
- 6.3.5.2 At least one exhaust duct shall extend down to the bilge of the space from which the fumes are to be expelled. If the space is an engine space, the exhaust duct entrances shall be located as nearly as practicable under the engine, or engines.
- 6.3.5.3 Duct termination in bilges shall be secured above the level of normal accumulations of bilge water.
- 6.3.5.4 Ventilation openings shall be located, where practicable, on the deck, but so located to minimize the ingress of water, taking into account all service conditions of heel, trim, wave action, loading, and reverse operations.

### 6.3.6 Ducts

- 6.3.6.1 The minimum collective internal cross-sectional area of ducts shall be calculated as per *ABYC Standards for Small Craft H-2*.
- 6.3.6.2 If the engine or fuel tank space connects to an adjoining closed space, the total net volume of both the space and closed space shall be used to determine the required duct size.

- 6.3.6.3 Non-metallic materials used for ventilating ducts and components installed below deck shall be capable of continuous exposure to a temperature range of  $-30^{\circ}\text{C}$  to  $85^{\circ}\text{C}$  without failure.
- 6.3.6.4 Non-metallic ventilating ducts and components shall be installed at least 230 mm (9 in) clear to the side and below, and 460 mm (18 in) above any surface capable of reaching a temperature of  $150^{\circ}\text{C}$ , unless those components are designed for use in higher temperature locations.

### **6.3.7 Cows and Ventilation Openings**

- 6.3.7.1 External openings of intakes and exhausts shall be located and oriented to prevent entry of fuel vapors. In no instance shall the intakes and exhausts be closer than 15 inches (380mm) from the gasoline fill and tank vent fittings.
- 6.3.7.2 No component of the ventilation system shall restrict the minimum required duct size.
- 6.3.7.3 Cowl ventilators shall be rated and labeled with the maximum effective cross-sectional area.
- 6.3.7.4 The cowl ventilator shall be installed over the duct to maintain the rated area in accordance with the cowl manufacturer's specifications.
- 6.3.7.5 Reduced airflow due to reduced area from screens shall be accounted for by using oversized cowls or ventilation openings.
- 6.3.7.6 If louvers are used as cowl ventilators, they shall create an airflow equivalent to that produced by the required minimum cowl ventilator size.

### **6.3.8 Blowers**

- 6.3.8.1 The underway ventilation system shall be supplemented by a mechanical blower in order to remove combustible vapours from engine spaces prior to starting the engine.
- 6.3.8.2 Blowers may be installed with separate ducting or installed in the underway exhaust duct as illustrated in Figure 6-2.
- 6.3.8.3 Blowers shall be mounted as high as practicable above the bilge low point to prevent contact with bilge fluid, except for blowers designed in combination with bilge pumps, which can be operated submerged.
- 6.3.8.4 Blower outlet fittings shall not have less effective area than blower intakes.
- 6.3.8.5 Blowers shall not be wired in the ignition circuit to run continuously, unless rated by the manufacturer for continuous operation.
- 6.3.8.6 Blower motors shall be of a sealed type or ignition protected and shall be suitable for marine atmosphere.

- 6.3.8.7 A blower instruction placard shall be provided at every engine ignition switch indicating the length of blower operating time that is required to clear the engine space prior to starting the engine.
- 6.3.8.8 The blower shall be designed for a minimum of four minutes continuous operation, more if required, to clear any space of vapours.
- 6.3.8.9 Table 6–1 provides the formulae for sizing of blowers in order to achieve complete evacuation in four (4) minutes.

**Table 6–1 Blower Ratings**

Net Engine Space Volume [V] (m <sup>3</sup> )	Rated Blower Capacity [Fr] (m <sup>3</sup> /min)	Blower Output [Fo] (m <sup>3</sup> /min)
2.83 or less	$F_r = 1.5 V$	$F_o = 0.6 V$
Greater than 2.83	$F_r = V/2 + 2.83$	$F_o = 0.2 V + 1.13$

## 6.4 Diesel Engine and Fuel Tank Space Ventilation

### 6.4.1 Application

- 6.4.1.1 This subsection applies to any vessel, regardless of length or accommodation, that has a diesel engine for propulsion or other purposes.

### 6.4.2 General

- 6.4.2.1 Due to the characteristics of diesel fuel and the closed nature of the diesel engine fuel system, neither mechanical nor natural ventilation is necessary to remove diesel fuel vapours.
- 6.4.2.2 Ventilating provisions and openings to the machinery space provided for the supply of combustion air shall accommodate the air requirements as stipulated by the engine manufacturer for each propulsion and auxiliary engine in that space. These openings may also function as means of providing natural ventilation.

## 6.5 Battery Spaces

- 6.5.1 Spaces containing batteries shall provide for the escape of hydrogen.

**Section 7.0**

F U E L   S Y S T E M S

**ISSUE NUMBER: 3**

**DATE: 2004 Edition**

**NUMBER OF PAGES: 13**

THIS ISSUE SUPERSEDES

Issue Number: 2

Dated: January 2002

Archived

## 7.1 Application

- 7.1.1 This section applies to all gasoline and diesel fuel systems for all small vessels, except where indicated otherwise.

## 7.2 General

- 7.2.1 A permanently installed fuel system shall provide protection from leakage caused by corrosion, shock, or fire.
- 7.2.2 All components of a fuel system, including tank penetrations and fittings, shall be accessible for inspection.
- 7.2.3 After installation, the fuel system, which includes fill pipes, tanks, vent pipes, delivery pipes, and return pipes, shall be hydrostatically pressure tested to a minimum of 21 kPa (3 lbs/in<sup>2</sup>).
- 7.2.4 The fuel system shall be designed and installed to contain at least 5% fuel expansion to minimize the risk of a fuel spill either into the vessel or the environment when:
- (a) the fuel tank is filled to its rated capacity; and
  - (b) the vessel is in the static floating position.
- 7.2.5 Fuel systems shall be liquid and vapour tight to the hull interior, except when:
- (a) permeation of hoses is within the limits of Society of Automotive Engineers – Standard SAE J1527, *Marine Fuel Hoses* (1993); and
  - (b) permeation of fuel tanks is within the limits of ABYC *Standards for Small Craft H-2, Ventilation of Vessels Using Gasoline*.
- 7.2.6 Fuel systems shall be capable of:
- (a) storage without operation at an ambient temperature range from –40°C to 80°C without failure or leakage; and
  - (b) operation at an ambient temperature range from –30°C to 80°C.
- 7.2.7 Fuel tank, fuel filter, or fuel line fittings shall not be installed over a source of ignition. Personal watercraft are exempt from this requirement.
- 7.2.8 All electrically operated components installed in GASOLINE fuel systems shall be ignition-protected.
- 7.2.9 Every drain plug or valve on every filter or fuel tank of a DIESEL system shall be:
- (a) of the type which cannot be opened inadvertently; or

(b) installed in a manner to guard against inadvertent opening.

7.2.10 Metal bowls shall be used for inboard GASOLINE engines and plastic bowls shall be used for outboard engines. Every fuel-water separator bowl used for gasoline engines must meet the requirement of National Fire Protection Association NFPA 302, *Fire Protection Standard for Pleasure and Commercial Motor Craft*

7.2.11 Every hose in a fuel system shall meet or exceed:

(a) the performance requirements of Society of Automotive Engineers – Standard SAE J1527, *Marine Fuel Hoses*; and

(b) the fire resistance tests requirements of ABYC *Standards for Small Craft H-24 for Gasoline Fuel Systems* or the fire resistance tests requirements of ABYC *Standards for Small Craft H-33 for Diesel Fuel Systems*, as applicable.

7.2.12 Every hose shall be permanently marked in capital letters and numerals at least 3 mm (0.12 in) in height and width and at intervals not greater than 305 mm (12 in) with the following information:

(a) type of hose;

(b) manufacturer's name or registered trademark; and

(c) year of manufacture.

7.2.12.1 Hoses less than 305 mm (12 in) in length may be tagged with the required marking.

## 7.3 Fuel Tanks

### 7.3.1 General

7.3.1.1 Every fuel tank shall be constructed to meet the minimum test requirements for mechanical strength and fire resistance, as detailed in ABYC *Standards for Small Craft H-24, Gasoline Fuel Systems*, or ABYC *Standards for Small Craft H-33, Diesel Fuel Systems*, as applicable.

7.3.1.2 A metallic fuel tank shall be constructed of materials in accordance with Table 7-1. Non-metallic materials are considered acceptable for corrosion resistance; however, all other requirements of this Standard must be met.

7.3.1.3 A fuel tank shall be constructed so that no external surface of the tank can retain moisture or spilled fuel.

7.3.1.4 A GASOLINE fuel tank shall have no openings in the bottom, sides, or ends.

7.3.1.5 Clean-out plates shall not be installed in GASOLINE fuel tanks; clean-out plates may be installed in the top or sides of DIESEL fuel tanks.

**Table 7-1 Fuel Tank Corrosion Resistance Requirements**

Material	Specification Sheet Thickness	Minimum Nominal	Gauge Processes (1)	Welding
Nickel-Copper	ASTM – B127 Class A	0.79 mm	22 U.S. std	Resistance Seam; Inert Gas Shielded Arc; Oxyacetylene
Copper-Nickel	ASTM – B122	1.14 mm	17 AWG	Inert Gas Shielded Arc; Oxyacetylene; Resistance
Copper (2)	ASTM – B152 Type E.T.P.	1.45 mm	15 AWG	Inert Gas Shielded Arc; Carbon Arc; Oxyacetylene
Copper-Silicon	ASTM – B97 Types A, B & G	1.27 mm	16 AWG	Inert Gas Shielded Arc; Carbon Arc; Oxyacetylene; Metal-Arc
Steel Sheet (3)	ASTM – A93	1.90 mm	14 Mfrs.	Metal-Arc; Oxyacetylene; Inert Gas Shielded Arc; Resistance
Aluminized Steel (5)	ASTM – A463	1.21 mm	18 Mfrs.	Metal-Arc; Oxyacetylene; Inert gas Shielded Arc; Resistance
Aluminum (4)	Alloy 5052 or 5083 or 5086	2.29 mm	—	Inert Gas Shielded Arc; Resistance
Stainless Steel	316 L	0.79 mm	22 U.S. std.	Metal-Arc; Oxyacetylene; Inert Gas Shielded Arc; Resistance

**Notes:**

- (1) Tank seams produced by the welding processes listed shall be ductile and non-porous.
- (2) Copper tanks shall be internally tin coated.
- (3) Steel sheet tanks, when constructed for gasoline, shall be galvanized inside and outside by the hot dip process.
- (4) Aluminum tank fitting plates shall be made of 5052, 5083, 5086, 6061 or 6063 aluminum or 300 series stainless steel.
- (5) Aluminized steel tanks shall have a corrosion inhibiting baked paint or equivalent coating not less than 0.0381mm thickness applied to the total tank exterior.

- 7.3.1.6 If baffles are provided, baffle openings shall be designed so that they do not prevent the fuel flow across the bottom or trap vapour across the top of the tank.
- 7.3.1.7 Threaded connections into fuel tanks shall be in accordance with American National Standard Taper Pipe Thread (NPT).
- 7.3.1.8 Cellular plastic used to encase metallic fuel tanks shall not change volume by more than 5% or dissolve after being immersed for 24 hours at 29°C in each of the following liquids:
- (a) reference fuel B, in accordance with American Society of Testing and Materials ASTM D471, *Standard Test Method for Rubber Property – Effects of Liquid*;
  - (b) No. 2 reference oil, in accordance with American Society of Testing and Materials ASTM D471, *Standard Test Method for Rubber Property – Effects of Liquid*; and
  - (c) a 5% solution of trisodium phosphate in water.
- 7.3.1.9 Cellular plastic used to encase metallic fuel tanks shall not absorb more than 0.58 kg (0.1 lbs.) of water per square metre (ft<sup>2</sup>) of cut surface.
- 7.3.1.10 Where plastic is bonded to a metallic tank, the adhesive strength of the bond shall exceed the cohesive strength of the plastic.
- 7.3.1.11 Non-polyurethane cellular plastic used to encase metallic fuel tanks shall have a minimum compressive strength of 410 kPa (60 lbs/in<sup>2</sup>) at a 10% deflection, measured in accordance with American Society of Testing and Materials ASTM D1622, *Standard Test Method for Apparent Density of Rigid Cellular Plastics*.
- 7.3.1.12 Polyurethane cellular plastic, which is used to encase metallic fuel tanks, shall have a minimum density of 50 kg/m<sup>3</sup> (3 lbs/ft<sup>3</sup>) measured in accordance with American Society of Testing and Materials ASTM D1622.
- 7.3.1.13 Rigid tubes and fill pipes that extend near the bottom of the tank shall have clearance to prevent contact with the bottom due to flexing of the tank.
- 7.3.1.14 Every fuel tank shall have permanently affixed to it a label showing as a minimum:
- (a) type of fuel or fuels for which the tank is suitable;
  - (b) the manufacturer's name, or logo, and address;
  - (c) the month and the year of manufacture, or the lot number and year of manufacture;
  - (d) its capacity in litres (and optionally in gallons); and
  - (e) a statement that the tank meets the requirements of the *Construction Standards for Small Vessels* – TP1332 or an equivalent standard to TP1332, e.g. United States Government; CFR33 183.510 (a).

- 7.3.1.14.1 **Note:** In lieu of the requirements of 7.3.1.1 to 7.3.1.13, the design and construction of the fuel tank may conform to an equivalent standard to those requirements, e.g. United States Government; CFR33, 183.510 (a).
- 7.3.1.15 Every letter and numeral on any fuel tank shall be:
- (a) at least 1.5 mm ( $1/16$  in) in height and width; and
  - (b) be of a contrasting colour to the basic colour of the label or be embossed on the label.
- 7.3.1.16 Every tank label shall be readily visible and legible on the tank as installed.

### 7.3.2 Fuel Tank Installation

- 7.3.2.1 Every fuel tank, including those encased in cellular plastic foam or fibre reinforced plastic, shall be so installed that all connections, accessories, and labels are accessible for inspection and maintenance.
- 7.3.2.2 A GASOLINE fuel tank shall not be made integral with the hull.
- 7.3.2.3 No fuel tank shall support any deck, bulkhead, or structural component, or bear any extraneous load unless it is designed and built to do so.
- 7.3.2.4 Adequate supports shall be fitted as necessary to ensure the structural integrity of every tank.
- 7.3.2.5 A fuel tank shall be installed and restrained to provide as close to no movement as possible.
- 7.3.2.6 Metallic fuel tank supports and hold-downs shall be isolated from the tank surface by non-abrasive, non-absorbent and non-conductive materials.
- 7.3.2.7 Cellular plastic shall not be used as the sole support for a metal fuel tank.
- 7.3.2.8 Cellular plastic used as the sole support for a non-metallic fuel tank shall meet the requirements of American Society of Testing and Materials ASTM D1621, *Standard Test Method for Compressive Properties of Rigid Cellular Plastic*, or American Society of Testing and Materials ASTM D1622, *Standard Test Method for Apparent Density of Rigid Cellular Plastic*.
- 7.3.2.9 No cellular or fibre reinforced plastic fuel tank encasement shall permit water to:
- (a) collect between the plastic and the tank; or
  - (b) be held against the tank by capillary action.
- 7.3.2.10 Metallic fuel tanks installed above a flat surface shall be separated from the surfaces by at least a 6 mm ( $1/4$  in) air space when filled with fuel.

### 7.3.3 Fuel Tank Gauges

7.3.3.1 Every fuel tank shall be installed with mechanical or remote reading fuel gauges, unless the tank installation permits sounding.

### 7.3.4 Fuel Tank Fill System

7.3.4.1 Fuel fill lines shall be hose or metal pipe.

7.3.4.2 Each fuel tank shall have an individual fill line.

7.3.4.3 Deck fill plates:

- (a) shall be located at least 380 mm (15 in) from any fresh air intake for gasoline systems;
- (b) shall not permit a fuel overflow to enter the vessel;
- (c) shall be permanently marked GASOLINE, GAS, or with the ISO symbol for gasoline in GASOLINE systems; or
- (d) shall be permanently marked DIESEL, or with the ISO symbol for diesel in DIESEL systems.

7.3.4.4 Fuel shall not blow back through the fuel fitting when the tank is being refueled at a rate of 23 L/min (6 U.S. gal/min).

7.3.4.5 The fill pipe installation shall be self-draining and lead directly from the deck fill to the tank in such a way as to prevent any vapour locks.

7.3.4.6 The minimum inside diameter of the fill system shall be 32 mm (1<sup>1</sup>/<sub>4</sub> in) In order to maintain the minimum diameter, the minimum hose ID using standard fittings shall be 38 mm (1<sup>1</sup>/<sub>2</sub> in).

7.3.4.7 The hose in a fuel tank fill system shall be secured to the deck fill and the tank with corrosion resistant and galvanically compatible fittings consisting of:

- (a) a swaged sleeve;
- (b) a sleeve and threaded insert; or
- (c) two metallic hose clamps of a type that is not dependent upon spring tension for compressive force.

7.3.4.8 Every hose clamp used in a tank fill system shall:

- (a) be used with a hose that is designed for clamps;
- (b) have a minimum nominal band width of 12 mm (1/2 in);

- (c) fasten over the hose and the spud, pipe, or hose fitting; and
- (d) be installed not be less than 12 mm ( $1/2$  in) from the end of the hose.

- 7.3.4.9 Fuel fill hose shall be of neoprene fabric or wire reinforced neoprene material that meets the requirements for fuel hose in 7.2.11 and 7.2.12.
- 7.3.4.10 Every fuel fill hose installed in the engine compartments shall be USCG Type A1 or A2.
- 7.3.4.11 Fuel hose shall not be installed on helical threading or knurling that provides a path for fuel leakage.

### 7.3.5 Fuel Tank Venting Systems

- 7.3.5.1 Every fuel tank shall have a venting system that:
- (a) discharges fuel vapours overboard;
  - (b) does not allow a fuel overflow to enter the vessel;
  - (c) minimizes the accidental entry of water; and
  - (d) prevents pressure in the tank from exceeding 80% of the rated pressure of the tank.
- 7.3.5.2 Every flexible vent pipe shall be:
- (a) a minimum of 15 mm ( $5/8$  in) I.D. and constructed of material that conform to the performance requirements of *ABYC Standards for Small Craft H-24* and the fire resistance tests requirements of *ABYC Standards for Small Craft H-24* for GASOLINE fuel systems or the fire resistance tests requirements of *ABYC Standards for Small Craft H-33* for DIESEL fuel systems, as applicable;
  - (b) installed so that it does not kink or sag; and
  - (c) secured with corrosion resistant clamps of a type that is not dependent upon spring tension.
- 7.3.5.3 The vent shall be fitted with a flame arrestor that:
- (a) has an effective area not less than the minimum required for the vent line; and
  - (b) can be cleaned, unless the vent itself is a flame arrestor.
- 7.3.5.4 Tank vent systems shall be self-draining and connect to the highest point of the fuel tank as installed in the vessel under conditions of normal operation and normal trim.

## 7.4 Fuel Lines

- 7.4.1 (a) All fuel lines, including fill, vent, delivery, and return, shall be protected from damage.
- (b) Flexible fuel supply lines installed in engine space must be type A1 hose.

- 7.4.2 Every metallic fuel line:
- (a) shall be made of seamless annealed copper, nickel-copper, or copper-nickel;
  - (b) shall have a minimum wall thickness of 0.75 mm ( $1/32$  in); and
  - (c) shall be galvanically protected from the structure in aluminum hulls.
- 7.4.3 A metallic fuel line shall be attached to the vessel structure within 102 mm (4 in) of the connection of a flexible fuel line.
- 7.4.4 A section of flexible line with sufficient slack to absorb vibration shall be installed where a rigid fuel line terminates at:
- (a) an engine or fuel filter connection; or
  - (b) a fuel tank that may vibrate.
- 7.4.5 The inside diameter of a hose shall not exceed the minimum outside diameter of the connecting spud, pipe, or fitting by more than the tolerance shown in Table 7-2.

**Table 7-2 Fitting and Hose Connection Tolerances**

Minimum Outside Diameter of the Fitting	Tolerance of Inside Diameter of Hose
Less than 9.5 mm ( $3/8$ in)	0.51 mm (0.020 in)
9.5 mm to 25 mm ( $3/8$ in to 1 in)	0.89 mm (0.035 in)
Greater than 25 mm (1 in)	1.65 mm (0.065 in)

- 7.4.6 All fuel distribution systems shall be provided with anti-siphon protection by at least one of the following:
- (a) ensuring that no part of the line can, if separated at any point, fall below the lowest level of the tank suction;
  - (b) keeping all parts of the fuel distribution and return lines above the level of the fuel line to tank connection to the carburetor inlet or its equivalent, e.g., throttle body, port fuel injection, or a location where fuel leakage cannot enter the vessel when the vessel is in its static floating position;
  - (c) fitting an anti-siphon demand valve at the fuel line to tank connection that can be opened only by the fuel pump suction to withdraw fuel from the tank and that will remain closed when the fuel pump is not operating, thereby preventing siphon action created by a break or leakage at any point in the fuel distribution system.
  - (d) installing at the fuel tank connection an electrically operated valve that when used:
    - (i) opens only when the ignition switch is on,
    - (ii) is capable of being operated manually, and

- (iii) meets the fire resistance tests requirements of ABYC *Standards for Small Craft H-24* for GASOLINE fuel systems or the fire resistance tests requirements of ABYC *Standards for Small Craft H-33* for DIESEL fuel systems, as applicable;
  - (e) installing a manual shut-off valve directly at the fuel tank connection, arranged to be readily accessible for operation from outside the compartment if the fuel tank top is located below the level of the carburetor inlet or the fuel line is rigid metal or USCG Type A1 hose.
- 7.4.6.1 **Note:** Readily accessible from outside, the compartment includes a shut-off valve installed at the tank, close to, and directly below, an access port in the deck through which the valve can be operated.
- 7.4.7 If the length of fuel line from the tank outlet to the engine inlet is greater than 3600 mm (11 ft 10 in), a second manual shut-off valve shall be installed at the fuel inlet connection to the engine.
- 7.4.8 Fuel systems shall be equipped with an independently supported fuel strainer or filter, complying with subsection 7.5, if a strainer or filter is not incorporated in the pick-up tube.
- 7.4.9 On vessels with multiple fuel tanks and a fuel system that returns fuel to the tank (such as fuel injection), the system shall return unused fuel to the same tank from which it was drawn.
- 7.4.10 The design and construction of the fuel system requires a warning label indicating that modifying this system may result in a fuel overflow. See ABYC *Standards for Small Craft T-24, Owner/Operator's Manuals*.

## 7.5 Fittings, Joints, and Connections

- 7.5.1 Every fuel system fitting, joint, and connection shall be accessible for inspection, maintenance, and removal, without the removal of any permanent vessel structure.
- 7.5.2 Fuel lines shall have the minimum number of connections practicable.
- 7.5.3 Hoses used in the fuel tank fill system shall be secured to pipes (smooth pipes acceptable), spuds, or other fittings at each connection, by at least two (2) metallic clamps with nominal band widths of at least 12 mm ( $1/2$  in).
- 7.5.4 Every hose used in the fuel tank vent system or the fuel distribution and return line system shall be secured to a mating spud, pipe, or fitting that is formed or machined to provide serrations (at least 0.38 mm [0.15 in] depth) or a bead. At least one corrosion resistant metallic clamp shall be used with a minimum nominal band width. (Table 7-3)

**Table 7-3 Minimum Hose Clamp Band Width**

Outside Diameter of Hose	Clamp Width
Less Than 11 mm ( $7/16$ in)	6 mm ( $1/4$ in)
11 mm to 20 mm ( $7/16$ in. to $25/32$ in)	8 mm ( $3/8$ in)
Greater than 20 mm ( $25/32$ in)	12.5 mm ( $1/2$ in)

- 7.5.5 Every clip, strap, or hose clamp, including fasteners:
- shall be made from corrosion resistant material;
  - shall not cut or abrade a any fuel line; and
  - shall not be separated by a tensile force of 5 N when tested under the fire resistance requirements for fuel systems, as set forth in *ABYC Standards for Small Craft H-24* or *ABYC Standards for Small Craft H-33*, as applicable.
- 7.5.6 Every hose clamp:
- shall be used with a hose that is designed for clamps;
  - shall be at least one clamp width from the hose end;
  - shall be fitted beyond the head or flare, or over the serrations of the mating spud, pipe, or hose fitting; and
  - shall not depend on spring tension for compressive force.
- 7.5.7 The minimum nominal band width of every hose clamp shall be determined by the outside diameter of the hose, as shown in Table 7-3.
- 7.5.8 A gasoline fuel system shall not have a fitting for draining fuel other than a plug that is used to service the fuel filter or strainer and that:
- has a tapered pipe-thread;
  - is a screw type fitted with a locking device other than a split lock-washer; and
  - does not create a galvanic cell with the housing that will accelerate corrosion.

## 7.6 Fuel Line Valves

- 7.6.1 Valves shall pass the 2.5-minute fire test as specified in United States Government CFR 33, Section 183.590 and *ABYC Standards for Small Crafts H-24.5.7*.
- 7.6.2 Electrically operated valves shall meet the requirements of Underwriters Laboratories UL 429, *Electrically Operated Valves*.

- 7.6.3 The unit shall incorporate means for independent mounting designed to relieve strain from connected fuel lines.
- 7.6.4 Manually operated valves shall be designed with positive stops in the open and closed positions, or shall indicate their opened and closed positions.
- 7.6.5 Electrically operated shut-off valves shall be connected to be energized to open when the engine ignition switch is on. A provision for manual operation shall be incorporated in the design.
- 7.6.6 Tapered plug valves with an external spring shall not be used.

## 7.7 Fuel Filters and Strainers

- 7.7.1 Every fuel filter or strainer shall meet the fire resistance requirements for fuel systems set forth in *ABYC Standards for Small Craft H-24.5.7*, unless the filter or strainer is inside the fuel tank.
- 7.7.2 All fuel filters or strainers shall be supported on the engine or vessel structure independent from the fuel line connections, unless the filter or strainer is inside the fuel tank.
- 7.7.3 Filters, separators, and strainers shall meet the requirements of Underwriters Laboratories UL 1105, *Standard for Marine Use Filters, Strainers, and Separators*.
- 7.7.4 Fuel tank withdrawal pipes that are fitted with fuel filters:
- (a) shall extend as close to the bottom of the tank as practicable, to allow maximum drainage;
  - (b) shall permit water contamination to be withdrawn from the tank with the fuel; and
  - (c) shall be resistant to salt water, alcohol, and stale fuel.

## 7.8 Fuel Pumps

- 7.8.1 Every fuel pump shall be installed on the engine or within 305 mm (12 in) of the engine, with a maximum delivery hose length of 1220 mm (48 in) unless it is a fuel pump used to transfer fuel between tanks.
- 7.8.2 A diaphragm pump shall not leak fuel if the primary diaphragm fails.
- 7.8.3 Every electric fuel pump shall incorporate an automatic cutoff designed to eliminate fuel pressure at the outlet when the engine stops for any cause.
- 7.8.4 The outlet pressure of electrically operated fuel pumps, except for electric fuel pumps used to transfer fuel between tanks, shall be rated or controlled to the maximum carburetor fuel inlet pressure specified by the engine manufacturer.

- 7.8.5 A momentary type switch may override the automatic cutoff for the purpose of priming or starting the engine.

## 7.9 Grounding

- 7.9.1 Each metal or metallic plated component of the fuel fill system and fuel tank that is in contact with the fuel must be grounded so that its resistance to the vessel ground is less than 1 ohm.
- 7.9.2 Ground wire ends shall not be clamped between the fill pipe and hose.
- 7.9.3 Static conductive neoprene tubing or piping that is used in lieu of metallic conductors shall be:
- (a) clearly marked as static conductive; and
  - (b) installed in direct contact with non-painted attachment surfaces.

## 7.10 Carburetors (Gasoline)

- 7.10.1 Every carburetor, when tested to the requirements of the fire resistance test set forth in *ABYC Standards for Small Craft H-24*, Appendix A, shall not leak more than 5 mL of fuel in 30 seconds when:
- (a) the float valve is open;
  - (b) the carburetor is at half throttle; and
  - (c) the engine is cranked without starting, or the fuel pump is delivering the maximum pressure specified by the manufacturer.
- 7.10.2 Every up-draught and horizontal-draught carburetor shall have a device that:
- (a) collects and holds fuel that flows out of the carburetor venturi section toward the air intake;
  - (b) prevents collected fuel from being carried out of the carburetor assembly by the shock wave of a backfire or reverse airflow; and
  - (c) returns the collected fuel to the engine induction system after the engine starts.
- 7.10.3 Every engine shall be equipped with an effective means of backfire flame control by the use of an effective flame arrestor.
- 7.10.4 Every inboard engine that uses a carburetor shall be so designed and fitted as to prevent gasoline from leaking into the bilge.

## 7.11 Fuel System Labeling

- 7.11.1 A warning label shall be placed in a readily visible location on the vessel, or at a point of frequent servicing of the vessel. Labelling shall not weaken the tank.
- 7.11.2 The label shall comply with ABYC *Standards for Small Craft* T-5, "Safety, Signs and Labels," and shall contain at least the following informational elements:
- (a) the hazard intensity signal word;
  - (b) nature of the hazard;
  - (c) consequences that can result if the instructions to avoid the hazard are not followed; and
  - (d) instructions on how to avoid the hazard.

**Figure 7-1 Example of Warning Label**



- 7.11.3 Each valve in the fuel system shall be clearly marked with its function and with what each position means.

## 7.12 Outboard Motor Installations

- 7.12.1 The following additional requirements apply to all outboard installations.
- 7.12.2 All permanent fuel lines in outboard motor vessels shall terminate adjacent to the transom, so that any leakage will not enter the vessel.
- 7.12.3 Quick disconnect fittings used between fuel distribution lines and outboard motors shall automatically shut off fuel flow when disconnected.
- 7.12.4 No pressurized tanks shall be built into or be permanently attached to any hull.

**Section 8.0**

**ELECTRICAL SYSTEMS**

**ISSUE NUMBER: 3**

**DATE: 2004 Edition**

**NUMBER OF PAGES: 19**

THIS ISSUE SUPERSEDES

Issue Number: 2

Dated: January 2002

Archived

## 8.1 Application

- 8.1.1 This section applies to all small vessels that have gasoline or diesel engines for propulsion or electrical generating power or LPG (Liquefied Petroleum Gas) or CNG (Compressed Natural Gas) equipment on board.

## 8.2 Alternative

- 8.2.1 The requirements of ABYC *Standards for Small Craft E-11 AC and DC Electrical Systems on Boats* and *E-10 Storage Batteries* may be met instead of the requirements of sections 8.3 to 8.13.

## 8.3 General

- 8.3.1 All switches and controls shall be marked to indicate their usage except where there is a switch or electrical control whose function is obvious and where the operation of the device could not, under normal operation, cause a hazardous condition.
- 8.3.2 Single-pole breakers shall be installed in the positive conductor.
- 8.3.3 Switches shall be rated for the voltage and the current rating of the connected load of the circuit.
- 8.3.4 Electrical equipment, such as ignition systems, motors, pumps, fans, and controllers, shall be marked or identified with the following:
- (a) manufacturer;
  - (b) product ID, serial number, type, model;
  - (c) voltage, amperage, wattage;
  - (d) polarity; and
  - (e) ignition protected, if applicable;
- 8.3.5 Circuit Breakers shall:
- (a) have the same DC voltage rating as the system voltage;
  - (b) be of the trip-free, manual reset type;
  - (c) have an interrupting capacity to meet the system requirements; and
  - (d) be in compliance with Underwriters Laboratories UL 1500, *Standard for Ignition-Protection Test for Marine Products*, if located in the space.

- 8.3.6 Fuses shall be:
- (a) of the same nominal voltage as the system voltage;
  - (b) of an interrupting capacity to meet system requirements; and
  - (c) in compliance with Underwriters Laboratories UL 1500, *Standard for Ignition-Protection Test for Marine Products*, where applicable.
- 8.3.7 Every integral overcurrent protect device without manual reset is permitted for use provided the circuit is protected by a fuse or trip-free breaker.
- 8.3.8 All permanently installed electrical equipment and appliances shall be securely mounted to the ship's structure.
- 8.3.9 With the exception of engine mounted equipment, all DC appliances and fixed electrical equipment shall be designed so that all current carrying parts are insulated from exposed electrically conductive parts.
- 8.3.10 The following devices need not comply with paragraph 8.3.9 if one conductor is connected to the exposed electrically conductive parts, provided that the connected conductor is the negative conductor, the polarity of both the negative and positive connections are identified, the device is mounted only on a non-conductive surface, and the device is not bonded:
- (a) communication and audio equipment;
  - (b) electronic equipment;
  - (c) instruments and instrument clusters;
  - (d) cigarette lighters;
  - (e) liquid level gauge transmitters; and
  - (f) navigation lights operating at 12 V or less.
- 8.3.11 Every exposed conductive non-current part of electrical equipment that may normally be in contact with bilge or seawater shall be connected to a DC grounding system, except for small vessels not equipped with a DC grounding system, double insulated devices, and isolated metal parts in non-conductive material.
- 8.3.12 Grounded liquid level gauge transmitters mounted on metallic fuel tanks or tank plates shall have the transmitter negative return conductor connected directly to the engine negative terminal or its bus. This conductor shall serve as the tank bonding or static ground conductor. Where this conductor is employed as the bonding conductor, it shall be not less than 8 AWG, and no other device shall be connected to the conductor.
- 8.3.13 The negative terminal of the battery and the negative side of the DC distribution system shall be connected to the engine negative terminal or its bus. The negative return on vessels with outboard motors shall be connected to the battery negative terminal unless provisions have been specifically provided for the return to be connected to the motor negative terminal by the outboard manufacturer.

- 8.3.14 Where an accessory negative bus is used, the following requirements apply:
- (a) all the connections of the accessories to the bus shall be branch circuits from the same panelboard;
  - (b) the negative bus, the negative return conductors, terminals, and connections shall have an ampacity equal to the panelboard feeder; and
  - (c) the negative return conductors from the panelboard feeding the branch circuits, using the accessory bus, shall be the same size as the positive feeder to the panelboard.
- 8.3.15 Where the DC distribution system is a two-wire system with supply and return, the engine block may be used as the common return for accessories mounted on the engine, except on metallic vessels where the engine is not isolated from the hull.
- 8.3.16 If a small vessel with a grounded DC system has a multiple engine installation with grounded cranking motors that includes an auxiliary generator engine(s), the engines shall be connected to each other by a common conductor that can carry the starting current of each of the grounded cranking motor circuits. Multiple outboard motors shall be connected at the negative battery terminal
- 8.3.17 If a small vessel is equipped with a crossover (parallel) cranking motor system in a multi engine installation, including auxiliary generator(s), the engine shall be connected with a cable large enough to carry the cranking motor circuit; this cable shall be in addition to and independent of any other electrical connections to the engines including those in subsection 8.3.16, except in the case of ungrounded DC systems or outboard motors.
- 8.3.18 If a paralleling switch is installed in crossover circuitry of 8.3.17, it shall be rated to carry the largest cranking motor current. The switch may be of a maintained type or solenoid operated.

## 8.4 Ignition Protection

- 8.4.1 Every electrical component shall be ignition protected in accordance with Society of Automotive Engineers Standard SAE J1171, *External Ignition Protection of Marine Electrical Devices* or Underwriters Laboratories UL 1500, *Ignition Protection Test for Marine Products* unless the component is isolated from the fuel source, such as engines, stoves, valves, connections, or other fittings on vent lines, fill lines, distribution lines, or fuel tanks.
- 8.4.1.1 Exceptions to 8.4.1 are the following:
- (a) any small vessel using diesel fuel as the only fuel source; and
  - (b) electrical devices in accommodation spaces or open compartments, or both, having at least 97 cm<sup>2</sup> of open area per cubic metre of net compartment volume exposed to the atmosphere outside of the small vessel.

- 8.4.1.2 Electrical devices in compartments containing LPG or CNG appliances, cylinders fittings, valves, or regulators shall be ignition protected (refer to paragraph 8.4.1.1 for exceptions).
- 8.4.2 Isolation of an electrical component from a fuel source shall be provided by:
- (a) a bulkhead that meets the requirements of paragraph 8.4.3 and that is located between the electrical component and the fuel source;
  - (b) the installation of the electrical component with provision of a means to prevent fuel and fuel vapours from becoming exposed to the electrical component; or
  - (c) a space that is open to the atmosphere and that provides at least 600 mm (24 in) between the fuel source and the electrical component.
- 8.4.3 A bulkhead, as detailed in paragraph 8.4.2 shall:
- (a) extend both vertically and horizontally at least the distance of the open space between the fuel source and the ignition source;
  - (b) resist a water level that is 305 mm (12 in) high or one-third the maximum height of the bulkhead, whichever is less, without seepage of more than 7.5 mL of fresh water per hour; and
  - (c) have no opening located higher than 305 mm (12 in) or one-third the maximum height of the bulkhead, whichever is less, unless:
    - (i) the opening is used for the passage of conductors, piping, ventilation ducts, mechanical equipment, or doors, hatches, and access panels, and
    - (ii) the maximum annular space around each item or door, hatch, or access panel is not larger than 6 mm ( $\frac{1}{4}$  in).
- 8.4.4 Fuel tank, fuel filter, or fuel line fittings shall not be installed over a source of ignition. All personal watercraft are exempt from this requirement.

## 8.5 Grounding

- 8.5.1 Where a small vessel has more than one gasoline engine, the grounded cranking motor circuits shall meet the requirements of 8.3.16.
- 8.5.2 The engine block may be used as the common return for accessories mounted on the engine, except on metallic small vessels, where the engine is not isolated from the hull.
- 8.5.3 A metallic hull or the grounding conductor shall not be used as the return conductor.
- 8.5.3.1 If one side of the DC system is grounded, it shall be of negative polarity.

- 8.5.3.2 In steel and aluminum small vessels, non-conducting exposed metal parts of electrical equipment that requires grounding shall be effectively grounded to the hull.
- 8.5.4 On small wood, fiber-reinforced plastic and composite vessels, a continuous ground conductor shall be installed to facilitate the grounding of non-conducting exposed metal parts of electrical, electronic, and communication equipment that requires grounding. The ground conductor shall terminate at a point on the main engine or at a copper plate of area not less than 0.2 m<sup>2</sup> fixed to the keel below the light waterline so as to be fully immersed under all conditions of heel or trim.
- 8.5.5 Every grounding conductor shall be of copper or other corrosion-resistant material and shall be securely installed and protected, where necessary, against damage and electrolytic corrosion.
- 8.5.6 Every grounding connection to the small vessel's structure, or on wood, fiber-reinforced plastic, and composite small vessels, to the continuous ground conductor, shall be made in an accessible position and shall be secured by a screw or connector of brass or other corrosion-resistant material used solely for that purpose.

## 8.6 Batteries

### 8.6.1 General

- 8.6.1.1 Batteries shall be installed in a dry, ventilated location above bilge water level, accessible for inspection and maintenance.
- 8.6.1.2 Batteries shall not be tapped for voltages other than the total voltage of the cells comprising the battery.
- 8.6.1.3 Batteries, as installed in every small vessel, shall be capable of inclinations of up to 40 degrees without leakage of electrolyte. A means shall be provided for containment of any spilled electrolyte.
- 8.6.1.4 Batteries shall be protected against mechanical damage by either location or an enclosure, and electrically protected by a non-conductive cover to protect metal objects coming in direct contact with the ungrounded terminals of the battery.
- 8.6.1.5 Every battery shall be secured so as not move more than 25 mm (1 in) when a pulling force of twice the battery weight is applied through the centre of gravity in each of the following five directions for one minute:
- (a) vertically;
  - (b) horizontally, fore and aft; and
  - (c) horizontally port and starboard.
- 8.6.1.6 Every metallic fuel line and fuel system component located within 305 mm (12 in) above the level of the top of an installed battery shall be shielded with dielectric material.

- 8.6.1.7 Means for adequate ventilation shall be provided to prevent the accumulation of hydrogen from the battery during charging or discharging cycles. Vented batteries shall not be installed in accommodation spaces.
- 8.6.1.8 The positive terminal of a battery shall be identified on the terminal or on the battery case near the terminal, with one of the following symbols:
- (a) "POS";
  - (b) "P"; or
  - (c) "+".
- 8.6.1.9 No battery terminal connector shall depend upon spring tension for its connection to the terminal.

## 8.6.2 Battery Disconnect Switch

- 8.6.2.1 A battery disconnect switch shall be installed in the positive conductor from each battery or group of batteries, with a cold cranking average rating greater than 800 amperes, except for small vessels less than 8.0 m (26 ft 3 in) in length.
- 8.6.2.1.1 The following devices may be connected to the battery side of the battery switch described in paragraph 8.6.2.1; however, each device shall be provided with circuit protection in accordance with section 8.9:
- (a) electronic equipment with continuously powered memory;
  - (b) safety equipment such as bilge pumps, alarms, CO detectors, and bilge blowers;
  - (c) battery charging equipment.
- 8.6.2.2 Battery switches shall be placed in a readily accessible location as close as practicable to the battery, or batteries.
- 8.6.2.3 Battery disconnect switches shall be capable of carrying the maximum current of the distribution system including the intermittent load of the starter motor circuit.
- 8.6.2.4 Remote controlled battery disconnect switches, if used, shall also permit safe manual operation at the switch.

## 8.7 Conductors

### 8.7.1 General – Systems Less Than 50 Volts

- 8.7.1.1 This subsection does not apply to:
- (a) communications systems;
  - (b) electronic navigation equipment;

- (c) resistance conductors that control circuit amperage;
- (d) high-voltage ignition systems, conductors, and terminations;
- (e) pigtails of less than 200 mm (8 in) of exposed length;
- (f) cranking motor conductors.

8.7.1.2 Every permanently installed cable and conductor shall:

- (a) have a minimum nominal voltage rating of 50 V; and
- (b) have stranded copper conductors with an insulation rated for a minimum temperature of 60°C; and
- (c) be of single or multi-conductor construction; and
- (d) be flame retardant, impervious to water absorption, and of an oil resistant type when installed in engine room spaces; and
- (e) be of a type as described in 8.7.1.3.

8.7.1.3 For the purpose of 8.7.1.2(e), the types are those that are:

- (a) listed in Table 8–1; or
- (b) listed for marine use by an independent testing laboratory that provides listing, labelling, and follow-up service; or
- (c) constructed in accordance with the latest editions of one of the following:
  - (i) CSA C22.2 No. 245, *Marine Shipboard Cable*; or
  - (ii) UL 1309, *Marine Shipboard Cable*; or
  - (iii) IEEE STD 45, *Recommended Practice for Electrical Installations on Shipboard*; or
  - (iv) IEEE STD 1580 *Recommended Practice for Marine Cable for Use on Shipboard and Fixed or Floating Platforms*; or
  - (v) requirements of Underwriters Laboratories UL 1426, *Electrical Cables for Boats*.

8.7.1.4 Conductors and flexible cords shall have the following surface markings:

- (a) type/style;
- (b) voltage rating;
- (c) wire size; and
- (d) temperature rating.

**Table 8-1 Wire Types**

Types	Description	Available Insulation	Types of Conductors
TW	Moisture Resistant, Flame Tested Thermoplastic	60°C	Single Conductors
TWU	Heat and Moisture Resistant Flame Tested Thermoplastic	60°C	Single Conductors
TWN	Heat and Moisture Resistant Flame Tested Thermoplastic	75°C	Single Conductors
TW 75	Heat and Moisture Resistant Flame Tested Thermoplastic	75°C	Single Conductors
TWU 75	Heat and Moisture Resistant Flame Tested Thermoplastic	75°C	Single Conductors
T 90 Nylon	Heat and Moisture Resistant Flame Tested Thermoplastic	90°C	Single Conductors or Multi-Conductors
RW 90	Heat and Moisture Resistant Thermoset	90°C	Multi-Conductors

8.7.1.5 Where flexible cords or power cables are used for portable equipment, they shall be of a type SO, ST, SJO, SJT, SJOW, or SJTW, as listed in the CSA *Canadian Electrical Code*, Part 1, or be of a similar cable that has been constructed to a recognized national standard.

8.7.1.6 Except for intermittent surges, no conductor shall carry a current greater than that specified in Table 8-2 for the conductor's gauge and temperature rating.

8.7.1.7 In circuits where voltage drop must be kept to a minimum, the following maximum voltage drops are permitted:

- (a) panelboard main feeders: 3%;
- (b) navigation light circuits: 3%;
- (c) electronic equipment circuits: 3%;
- (d) bilge blower and pump: 3%; and
- (e) all remaining circuits 10%.

(For the calculation of the above voltage drops, refer to Tables 8-3 and 8-4)

8.7.1.8 Conductors shall be not less than 16 AWG (1 mm), other than those conductors contained in manufacturer's equipment and communication circuits of less than 1 amp.

## 8.7.2 Wire Colour Coding

8.7.2.1 The colour coding shown in Table 8-5 identifies colours for DC general wiring purposes on vessels together with one selection of colours used for engine accessories. Other means of cable identification may be employed provided a wiring diagram of the electrical system indicating the method of identification is provided particular to the vessel electrical installation.

**Table 8-2 Allowable Amperage of Conductors**

Conductor Size		Temperature rating of conductor insulation						
(Circular Mils)	(AWG)	60°C	75°C	80°C	90°C	105°C	125°C	200°C
1 620	18	10	10	15	20	20	25	25
2 580	16	15	15	20	25	25	30	35
4 110	14	20	20	25	30	35	40	45
6 530	12	25	25	35	40	45	50	55
10 400	10	40	40	50	55	60	70	70
16 500	8	55	65	70	70	80	90	100
26 300	6	80	95	100	100	120	125	135
41 700	4	105	125	130	135	160	170	180
52 600	3	120	145	140	155	180	195	210
66 400	2	140	170	175	180	210	225	240
83 700	1	165	195	210	210	245	265	280
106 000	0	195	230	245	245	285	305	325
133 000	00 (2/0)	225	265	285	285	330	355	370
168 000	000 (3/0)	260	310	330	330	385	410	430
212 000	0000 (4/0)	300	360	385	385	445	475	510

**Correction Factors****Note 1 Correction for Temperature of Conductor**

Temperature Rating	60°C	75°C	80°C	90°C	105°C	125°C	200°C
Correction Factor	0.58	0.75	0.78	0.82	0.85	0.89	1.00

**Note 2 Correction for Number of Conductors**

Number of current carrying conductors	Correction Factor
3	0.70
4 to 6	0.60
7 to 24	0.50
25 or more	0.40

8.7.2.2 If coloured tape is employed for colour coding, it shall be not less than 5 mm ( $3/16$  in) wide and shall make at least two (2) complete turns around the conductor in a visible location adjacent to the terminal.

### 8.7.3 Secondary Circuits of Ignition Systems

8.7.3.1 Every conductor in a secondary circuit of an ignition system shall conform to Society of Automotive Engineers Standard SAE Standard J2031.

8.7.3.2 The connection of every ignition conductor to a spark plug, coil, or distributor shall have a tight fitting cap, boot, or nipple.

### 8.7.4 Conductors – Support and Protection

8.7.4.1 This subsection does not apply to communication systems, electronic navigation equipment, or high-voltage secondary conductors and termination in ignition systems.

8.7.4.2 Except for the first 1000 mm (3 ft 3 in) of a conductor leading from a battery terminal, every conductor or group of conductors shall be supported by clamps or straps at intervals not greater than 500 mm (1 ft 8 in) unless the conductor or group of conductors is enclosed in a rigid duct or conduit.

8.7.4.3 Non-metallic straps or clamps shall be resistant to oil, gasoline, and water, and shall not break under flexing at a temperature range of  $-34^{\circ}\text{C}$  to  $121^{\circ}\text{C}$  and where exposed to sunlight shall not be sensitive to ultraviolet radiation.

8.7.4.4 Where metal clamps are lined with an insulating material, the material shall be resistant to oil, gasoline, and water, and be compatible with the insulation or sheath.

8.7.4.5 Clamps, straps, ducts, or conduits shall be designed to prevent chafing or damage to the conductor insulation.

8.7.4.6 Provision shall be made to prevent stress being placed on any conductor that connects two components that can move in relation to each other.

8.7.4.7 Every conductor or group of conductors that passes through a bulkhead, structural member, junction box, or other rigid surface shall be protected from abrasion.

8.7.4.8 Every conductor shall be protected from damage due to exposure to heat sources capable of damaging the insulation.

8.7.4.9 Current carrying conductors shall be routed as high as practicable above the bilge water level and other areas where water may accumulate. If conductors must be routed in the bilge or other areas where water may accumulate, the wiring and connections shall be watertight.

8.7.4.10 AC and DC conductors or multiconductors shall be separately sheathed in conduit or cable or trunking or bundled, or otherwise kept separate from each other.

**Table 8-3 Conductor Sizes for 3% Drop in Voltage**

Length of Conductor from Source of Current to Device and Back to Source - Feet																			
Metres	3	4.5	6	8	9	12	15	12	20	25	27	30	33	36	40	43	45	48	52
Feet	10	15	20	25	30	40	50	60	70	80	90	100	110	120	130	140	150	160	170
<b>12 Volts - 3% Drop Wire Sizes (gage) - Based on Minimum CM Area</b>																			
Total Amps.*																			
3	18	16	14	12	12	10	10	10	8	8	6	6	6	6	6	6	6	6	6
10	14	12	10	10	10	8	6	6	6	4	4	4	4	4	2	2	2	2	2
15	12	10	10	8	8	6	6	6	4	2	2	2	2	2	2	1	1	1	1
20	10	10	8	6	6	6	4	4	2	2	2	2	1	1	1	0	0	0	2/0
25	10	8	6	6	6	4	4	2	2	1	1	1	0	0	0	2/0	2/0	2/0	3/0
30	10	8	6	4	4	4	2	2	1	0	0	0	0	2/0	2/0	3/0	3/0	3/0	3/0
40	8	6	6	4	4	2	2	1	0	2/0	2/0	2/0	2/0	3/0	3/0	4/0	4/0	4/0	4/0
50	6	6	4	2	2	2	1	0	2/0	3/0	3/0	3/0	3/0	4/0	4/0	-	-	-	-
60	6	4	4	2	2	1	0	2/0	3/0	4/0	4/0	4/0	4/0	-	-	-	-	-	-
70	6	4	2	1	1	0	2/0	3/0	3/0	4/0	4/0	-	-	-	-	-	-	-	-
80	6	4	2	1	0	0	3/0	3/0	4/0	-	-	-	-	-	-	-	-	-	-
90	4	2	2	0	2/0	2/0	3/0	4/0	4/0	-	-	-	-	-	-	-	-	-	-
100	4	2	2	0	2/0	2/0	3/0	4/0	-	-	-	-	-	-	-	-	-	-	-
<b>24 Volts - 3% Drop Wire Sizes (gage) - Based on Minimum CM Area</b>																			
Total Amps.*																			
5	18	18	18	16	16	14	12	12	12	10	10	10	10	10	8	8	8	8	8
10	18	16	14	12	12	10	10	10	8	8	6	6	6	6	6	6	6	6	6
15	16	14	12	12	10	10	8	8	6	6	6	6	4	4	4	4	4	4	2
20	14	12	10	10	10	8	6	6	6	4	4	4	4	2	2	2	2	2	2
25	12	12	10	10	8	6	6	6	4	4	4	4	2	2	2	2	2	2	1
30	12	10	10	8	8	6	6	4	4	4	2	2	2	2	2	1	1	1	1
40	10	10	8	6	6	6	4	4	2	2	2	2	1	1	1	0	0	0	2/0
50	10	8	6	6	6	4	4	2	2	2	1	1	0	0	0	2/0	2/0	2/0	3/0
60	10	8	6	6	4	4	2	2	1	1	0	0	0	2/0	2/0	3/0	3/0	3/0	4/0
70	8	6	6	4	4	2	2	1	1	0	0	2/0	2/0	3/0	3/0	3/0	3/0	4/0	4/0
80	8	6	6	4	4	2	2	1	0	0	2/0	2/0	3/0	3/0	3/0	4/0	4/0	4/0	-
90	8	6	4	4	2	2	1	0	0	2/0	2/0	3/0	3/0	4/0	4/0	4/0	4/0	4/0	-
100	6	6	4	4	2	2	1	0	2/0	2/0	3/0	3/0	4/0	4/0	4/0	-	-	-	-
<b>32 Volts - 3% Drop Wire Sizes (gage) - Based on Minimum CM Area</b>																			
Total Amps.*																			
3	18	18	18	18	16	16	14	14	12	12	12	12	10	10	10	10	10	10	8
10	18	16	16	14	14	12	12	10	10	10	8	8	8	8	8	6	6	6	6
15	16	16	14	12	12	10	10	8	8	8	6	6	6	6	6	6	6	4	4
20	16	14	12	12	10	10	8	8	6	6	6	6	4	4	4	4	4	4	2
25	14	14	12	10	10	8	8	6	6	6	6	4	4	4	4	2	2	2	2
30	14	12	10	10	8	8	6	6	6	4	4	4	4	2	2	2	1	1	1
40	12	12	10	8	8	6	6	4	4	4	2	2	2	2	2	1	1	1	1
50	12	10	8	8	6	6	4	4	2	2	2	2	2	1	1	0	0	0	0
60	10	10	8	6	6	4	4	2	2	2	2	1	1	0	0	0	2/0	2/0	2/0
70	10	10	6	6	6	4	2	2	2	1	1	0	0	0	2/0	2/0	2/0	3/0	3/0
80	10	8	6	6	4	4	2	2	1	1	0	0	0	2/0	2/0	3/0	3/0	3/0	3/0
90	8	8	6	6	4	2	2	2	1	0	0	2/0	2/0	2/0	3/0	3/0	3/0	4/0	4/0
100	8	6	6	4	4	2	2	1	0	0	2/0	2/0	2/0	3/0	3/0	3/0	4/0	4/0	4/0

\*Total current on circuit in amperage.

**Table 8-4 Conductor Sizes for 10% Drop in Voltage**

Length of Conductor from Source of Current to Device and Back to Source - Feet																			
Metres	3	4.5	6	8	9	12	15	18	20	25	27	30	33	36	40	43	45	48	52
Feet	10	15	20	25	30	40	50	60	70	80	90	100	110	120	130	140	150	160	170
<b>Total Amps.* 12 Volts - 10% Drop Wire Sizes (gage) - Based on Minimum CM Area</b>																			
5	18	18	18	18	18	16	16	14	14	14	12	12	12	12	12	10	10	10	10
10	18	18	16	16	14	14	12	12	10	10	10	10	8	8	8	8	8	8	6
15	18	16	14	14	12	12	10	10	8	8	8	8	8	6	6	6	6	6	6
20	16	14	14	12	12	10	10	8	8	8	6	6	6	6	6	6	4	4	4
25	16	14	12	12	10	10	8	8	6	6	6	6	6	4	4	4	4	4	2
30	14	12	12	10	10	8	8	6	6	6	6	4	4	4	4	2	2	2	2
40	14	12	10	10	8	8	6	6	6	4	4	4	2	2	2	2	2	2	2
50	12	10	10	8	8	6	6	4	4	4	2	2	2	2	2	1	1	1	1
60	12	10	8	8	6	6	4	4	2	2	2	2	2	1	1	1	0	0	0
70	10	8	8	6	6	6	4	2	2	2	2	1	1	1	0	0	0	2/0	2/0
80	10	8	8	6	6	4	4	2	2	2	1	1	0	0	0	2/0	2/0	2/0	2/0
90	10	8	6	6	6	4	2	2	2	1	1	0	0	0	2/0	2/0	2/0	3/0	3/0
100	10	8	6	6	4	4	2	2	1	1	0	0	0	2/0	2/0	2/0	3/0	3/0	3/0
<b>Total Amps.* 24 Volts - 10% Drop Wire Sizes (gage) - Based on Minimum CM Area</b>																			
5	18	18	18	18	18	18	18	18	16	16	16	16	14	14	14	14	14	14	12
10	18	18	18	18	18	16	16	14	14	14	12	12	12	12	12	10	10	10	10
15	18	18	18	16	16	14	14	12	12	12	10	10	10	10	10	8	8	8	8
20	18	18	16	16	14	14	12	12	10	10	10	10	8	8	8	8	8	8	6
25	18	16	16	14	14	12	12	10	10	10	8	8	8	8	8	6	6	6	6
30	18	16	14	14	12	12	10	10	8	8	8	8	8	6	6	6	6	6	6
40	16	14	14	12	12	10	10	8	8	8	6	6	6	6	6	6	4	4	4
50	16	14	12	12	10	10	8	8	6	6	6	6	6	4	4	4	4	4	2
60	14	12	12	10	10	8	8	6	6	6	6	4	4	4	4	2	2	2	2
70	14	12	10	10	8	8	6	6	6	6	4	4	4	2	2	2	2	2	2
80	14	12	10	10	8	8	6	6	6	4	4	4	2	2	2	2	2	2	2
90	12	10	10	8	8	6	6	6	4	4	4	2	2	2	2	2	2	1	1
100	12	10	10	8	8	6	6	4	4	4	2	2	2	2	2	1	1	1	1
<b>Total Amps.* 32 Volts - 10% Drop Wire Sizes (gage) - Based on Minimum CM Area</b>																			
5	18	18	18	18	18	18	18	18	18	18	18	16	16	16	16	14	14	14	14
10	18	18	18	18	18	18	16	16	14	14	14	14	12	12	12	12	12	12	12
15	18	18	18	18	18	16	14	14	14	12	12	12	12	10	10	10	10	10	10
20	18	18	18	16	16	14	14	12	12	12	10	10	10	10	10	8	8	8	8
25	18	18	16	16	14	14	12	12	10	10	10	10	10	8	8	8	8	8	8
30	18	18	16	14	14	12	12	10	10	10	10	8	8	8	8	6	6	6	6
40	18	16	14	14	12	12	10	10	8	8	8	8	8	6	6	6	6	6	6
50	16	14	14	12	12	10	10	8	8	8	6	6	6	6	6	6	6	4	4
60	16	14	12	12	10	10	8	8	8	6	6	6	6	6	6	4	4	4	4
70	14	14	12	10	10	8	8	8	6	6	6	6	6	4	4	4	4	2	2
80	14	12	12	10	10	8	8	6	6	6	6	4	4	4	4	2	2	2	2
90	14	12	10	10	8	8	6	6	6	4	4	4	4	2	2	2	2	2	2
100	14	12	10	10	8	8	6	6	6	4	4	4	4	2	2	2	2	2	2

\*Total current on circuit in amperage.

**Table 8-5 General Wiring Colour Code**

Colour	Use	
<b>Green or green w/yellow stripe(s)</b>	DC Grounding Conductors	
<b>Black or Yellow</b>	DC Negative Conductors	
<b>Red</b>	DC Positive Conductors	
<b>Engine and Accessory Wiring Colour Code</b>		
Colour	Item	Use
<b>Yellow w/red strip (YR)</b>	Starting circuit	Starting switch to solenoid
<b>Brown/yellow stripe (BY) or Yellow (Y) – see note</b>	Bilge blowers	Fuse or switch to blowers
<b>Dark Gray (Gy)</b>	Navigation lights	Fuse or switch to lights
	Tachometer	Tachometer sender to gauge
<b>Brown (Br)</b>	Generator armature	Generator armature to regulator
	Alternator charge light	Generator
		Terminal/Alternator
		Auxiliary terminal to light to regulator
	Pumps	Fuse or switch to pumps
<b>Orange (O)</b>	Accessory feed	Ammeter to alternator or generator output and accessory fuses or switches
		Distribution panel to accessory switch
<b>Purple (Pu)</b>	Ignition	Ignition switch to coil and electrical instruments
	Instrument feed	Distribution panel to electric instruments
<b>Dark blue</b>	Cabin and instrument lights	Fuse or switch to lights
<b>Light blue (Lt Bl)</b>	Oil pressure	Oil pressure sender to gauge
<b>Tan</b>	Water temperature	Water temperature sender to gauge
<b>Pink (Pk)</b>	Fuel gauge	Fuel gauge sender to gauge
<b>Green/stripe (G/x)</b>	Tilt down and/or trim in	Tilt and/or trim circuits
<b>Except G/Y</b>		
<b>Blue/stripe (Bl/x)</b>	Tilt up and/or trim out	Tilt and/or trim circuits

*Note on Table 8-5*

1. If yellow is used for DC negative, the bilge blower must be brown with yellow stripe.

- 8.7.4.11 Each conductor that is part of the electrical system, except for conductors integral with engines as supplied by their manufacturers, shall be clearly differentiated between AC and DC and identified as to its function in the system.
- 8.7.4.12 DC equipotential bonding conductors shall be identified by green or green with yellow stripe insulation, which shall not be used to indicate current carrying conductors, or may be uninsulated.
- 8.7.4.13 In situations where boxes must be located in wet locations, space surrounding the boxes or enclosures of at least 6 mm ( $1/4$  in) shall be provided to prevent the accumulation of water.

### **8.7.5 Conductors – Termination**

- 8.7.5.1 This subsection does not apply to communications systems and electronic navigation equipment.
- 8.7.5.2 Every connection to a screw terminal or stud that is outside a junction box or enclosure shall be connected by a closed-ring connector, eyelet connector, captive spade connector, mechanical locking connector, or spring locking connector.
- 8.7.5.3 Every stripped connector that is connected to a compression screw terminal that is outside a junction box or other enclosure shall be mechanically secured to avoid stress on the connection.
- 8.7.5.4 Every single friction connection, spring type connector, and multi-connector plug that is outside a junction box or enclosure shall be capable of withstanding a force of 27 N for one minute, applied along the axial direction of the conductor.
- 8.7.5.5 Subject to paragraph 8.7.5.6, a soldered connection that is outside a junction box or enclosure shall not be the sole means of connection between two or more conductors, or between a conductor and connector. If the connection is soldered, the connection shall be located or supported to limit the flexing of the conductor where the solder has changed the stranded flexible conductor to a solid conductor.
- 8.7.5.6 A conductor may be soldered to a connector that joins the conductor to a battery terminal or stud, provided that the length of the soldered joint is at least 1.5 times the diameter of the stranded portion of the battery conductor.
- 8.7.5.7 Every ungrounded terminal or stud that is continuously energized:
- (a) shall comply with paragraphs 8.7.3.1 and 8.7.3.2; or
  - (b) shall have a boot, nipple, cap, cover, or shield that prevents accidental short-circuiting at the terminal or stud.

- 8.7.5.8 Every termination that is composed of an ungrounded current carrying conductor, terminal fitting, and connector shall be protected from accidental short-circuiting with:
- (a) another termination from another circuit that is composed of an ungrounded current carrying conductor, terminal fitting, and connector; or
  - (b) any metal that is grounded.
- 8.7.5.9 No conductor shall be joined to another conductor by a twist-on wire nut, or wire screw.
- 8.7.5.10 Blade type friction connectors may be used provided:
- (a) the voltage drop from terminal to terminal does not exceed 50 mV for a 20-amp current flow; and
  - (b) the connection does not separate if subjected to a 27 N tensile force along the axial direction of the connector for one minute.
- 8.7.5.11 Terminal connectors of the ring or captive spade types shall be the same nominal size as the stud.
- 8.7.5.12 All connections shall be in locations protected from the weather or in weather tight enclosures.
- 8.7.5.12.1 Connections exposed to immersion shall be in watertight enclosures.
- 8.7.5.13 Metals used for terminal studs, nuts, or washers shall be corrosion resistant and galvanically compatible with the conductor and terminal. Aluminum and unplated steel shall not be used for studs, nuts, or washers in electrical circuits.
- 8.7.5.14 Mechanical and electrical joints shall be designed and installed to avoid damage to the conductors.
- 8.7.5.15 Setscrew connectors may be used provided the setscrew does not bear directly on the conductor strands.
- 8.7.5.16 Connectors of the crimp-on type shall be attached only by tools designed for the connector being used.
- 8.7.5.17 There shall not be more than four conductors connected to any one-stud terminal.
- 8.7.5.18 Where a conductor terminates at a switchboard, in a fixture, or in a junction box, a length of the conductor shall remain to provide strain relief at the terminal and allow for any future repairs.
- 8.7.5.19 Shanks of terminals shall be protected against accidental shorting except those employed for grounding lugs.
- 8.7.5.20 Harness-type wiring using multi-wire plugs and receptacles shall have cable clamps, molded connectors, insulation grips, or extended terminals to limit flexing at the connection point; the connectors where exposed to weather shall be weatherproof or watertight; each terminal shall be protected from accidental short-circuiting and the capacity shall meet or exceed the ampacity and temperature rating of the connecting conductors.

## 8.8 Receptacles

- 8.8.1 Receptacles and matching plugs used on DC systems shall not be interchangeable with those used on AC systems on the small vessel.
- 8.8.2 Receptacles installed in locations subject to rain, spray, or splash shall be protected by a cover with an effective weatherproof seal.
- 8.8.3 Receptacles, including connecting plugs, installed in areas subject to flooding or immersion shall be protected by an effective cover with a watertight seal.

## 8.9 Overcurrent Protection

### 8.9.1 General

- 8.9.1.1 This section does not apply to resistance conductors that control circuit amperage, conductors in secondary circuits of ignition systems, pigtails of less than 200 mm (8 in) of exposed length, and power supply conductors in cranking motor circuits.
- 8.9.1.2 Every ungrounded, current carrying conductor shall be protected by a manually reset, trip-free circuit breaker or fuse that shall be:
- (a) at the source of power for each conductor; or
  - (b) at the point where a conductor size is reduced to a smaller gauge; or
  - (c) at the origin of the circuit, if the circuit breaker or fuse has a current rating that prevents overloading of the smallest conductor in the circuit.
- 8.9.1.2.1 Overcurrent protection for each ungrounded conductor of a branch circuit shall be at the point of connection to panelboard or switchboard.
- 8.9.1.3 Except as provided in paragraph 8.9.1.4, the current rating of each circuit breaker or fuse shall not exceed the current rating of the smallest conductor in the circuit.
- 8.9.1.4 If the value specified in paragraph 8.9.1.3 does not correspond to a standard circuit breaker or fuse rating, the next larger rated circuit breaker or fuse may be used, provided it does not exceed 150% of the allowed current capacity of the conductor.
- 8.9.1.5 The voltage rating of each circuit breaker or fuse shall not be less than the nominal voltage of the circuit that it protects.

### 8.9.2 Special Applications

- 8.9.2.1 Every ungrounded supply conductor from a storage battery shall have a manually reset, trip-free circuit breaker or fuse, unless the supply conductor is in the main power feed circuit from the battery to an engine cranking motor.
- 8.9.2.2 The circuit breaker or fuse, as specified in paragraph 8.9.2.1 shall be within 1800 mm (5 ft 11 in) of the battery, as measured along the conductor, unless the circuit has a switch that disconnects the battery.

## 8.10 Panelboards

- 8.10.1 The front side of panelboards (i.e., switch and breaker operating face) shall be readily accessible, and the rear side (i.e., terminal and connection side) shall be accessible.
- 8.10.2 Panel boards shall be designed, constructed, and installed so that there are no exposed live parts accessible to the operator in the normal operating position.
- 8.10.3 Panel boards shall be weatherproof or protected from weather and splash.
- 8.10.4 Vessels equipped with both AC and DC electrical systems shall have their distribution from separate panel boards. If both systems share a common enclosure, it must have a partition or have other positive means provided to clearly separate the AC and DC sections from each other. Wiring diagrams to identify circuits, components, and conductors shall be included.
- 8.10.4.1 The switchboard or panel board shall be provided with clear permanent markings of the nominal voltage and types and provide circuit identification.

## 8.11 Non-Pleasure Craft Electrical Arrangements

### 8.11.1 Application

- 8.11.1.1 This section applies in respect of non-pleasure craft only.

### 8.11.2 Emergency Lighting for Non-Pleasure Craft Only

- 8.11.2.1 A system of emergency lighting shall be provided, to allow the passengers and crew to exit from any area of the vessel. The lighting units shall be of a self-contained type, rechargeable from the vessel's electrical distribution system, and fitted with a charge indicator. As an alternative to an emergency hard-wired lighting system, rechargeable or non-rechargeable portable hand lanterns of not less than the 6-V battery type may be provided. For those vessels with non-rechargeable lanterns, a spare battery shall be carried and batteries shall be replaced with new batteries annually.

### 8.11.3 Cables and Connectors

- 8.11.3.1 All cables shall have stranded copper conductors and a protective covering of either watertight metallic sheath or impervious non-metallic sheath that is compatible with the insulation and shall be rated for at least 75°C service. The cables shall be installed and terminated in accordance with subsections 8.7.4 and 8.7.5.
- 8.11.3.2 All connections shall be made in terminal or junction boxes providing mechanical and environmental protection.

## 8.12 Electrical Systems of 50 Volts or More – Pleasure Craft Only

### 8.12.1 Application

- 8.12.1.1 This subsection applies to pleasure craft only.
- 8.12.1.2 This subsection does not apply to:
- (a) communication systems;
  - (b) electronic navigation equipment;
  - (c) resistance conductors that control circuit amperage;
  - (d) conductors in secondary circuits of ignition systems; and
  - (e) pigtails of less than 200 mm (8 in) of exposed length.

### 8.12.2 General

- 8.12.2.1 Every permanently installed conductor in a circuit which has a nominal voltage of 50 V or more shall be not less than the nominal voltage of the system and shall:
- (a) (i) be covered with insulation classified as moisture resistant and flame retardant in accordance with the latest edition of the *Canadian Electrical Code*, Part I, or conform to the mechanical water absorption and flame retardant standards of Underwriters Laboratories UL 83, *Thermoplastic-Insulated Wires and Cables*, and
    - (ii) be of an oil resistant type when installed in engine spaces and bilge water areas; or
  - (b) conform to TP127 *Ship Electrical Standard*; or
  - (c) conform to the most recent edition of IEEE Standard 45, IEEE 1580; or
  - (d) be listed for marine use by an independent testing laboratory that provides listing, labeling, and follow-up service.

- 8.12.2.2 Where the nominal circuit voltage of each of three or more current carrying conductors in a duct, bundle, or cable is 50 V or more, the amperages of each of those conductors shall not exceed that listed in Table 8-2 multiplied by the correction factor in Note 2 of Table 8-2 for the applicable number of conductors.
- 8.12.2.3 The installation of the electrical equipment in systems of 50 V or over shall conform to Transport Canada *Marine Electrical Standards*, TP127, Part 1 or *ABYC Standard for Small Vessels* Chapter 8.

### 8.13 Conductors in Circuits of 50 Volts or More – Non-Pleasure Craft

- 8.13.1 Permanently installed electrical systems of 50 V or over shall conform to Transport Canada *Marine Electrical Standards*, TP127, Part 1, or *ABYC Standards for Small Craft*, Chapter 8.
- 8.13.2 All connections shall be made in terminal or junction boxes, which shall provide mechanical and environmental protection.

Archived

**Section 9.0**

**M A C H I N E R Y   S Y S T E M S**

**ISSUE NUMBER: 3**

**DATE: 2004 Edition**

**NUMBER OF PAGES: 4**

THIS ISSUE SUPERSEDES

Issue Number: 2

Dated: January 2002

Archived

## 9.1 Propulsion Engines and Systems

### 9.1.1 Application

9.1.1.1 This section applies in respect of non-pleasure craft, except for 9.1.7, "Exhaust Systems," which applies to all small vessels.

### 9.1.2 General

9.1.2.1 Where persons may come in contact with moving machinery parts, guards shall be fitted where practicable.

### 9.1.3 Engine Starting

9.1.3.1 The machinery shall have either mechanical, hand, or electric starting.

9.1.3.2 Charging facilities for the batteries shall be automatic. Where auxiliary batteries are fitted, it is recommended that they be capable of being connected in parallel to provide additional starting power.

### 9.1.4 Operating Station Controls and Gauges

9.1.4.1 The following shall be provided at the vessel's operating station, where applicable:

- (a) engine oil pressure and engine coolant temperature indicators for inboard engine;
- (b) fuel capacity gauges, unless other adequate means to determine the amount of fuel is provided;
- (c) battery charging gauges;
- (d) controls for navigation light, steering equipment, etc.;
- (e) control and instructions for the blowers;
- (f) high bilge indicator;
- (g) fire detection panel and alarms; and
- (h) engine shut-off device.

### 9.1.5 Gasoline Engines Ventilation and Instructions

9.1.5.1 In every enclosed machinery space where gasoline is present, there shall be power ventilation that shall be designed for continuous operation to clear the space(s) of vapours in not less than 4 minutes of operation prior to starting. A clear permanent instruction placard covering this operation shall be mounted at the ignition switch on the control console.

## **9.1.6     Shafting and Propellers**

9.1.6.1     The propulsion machinery manufacturer's recommendations or other authorities' criteria, as recognized by the marine community, shall be taken into account when determining the material and dimensions of shafting and propellers.

## **9.1.7     Exhaust Systems – All Small Vessels**

### **9.1.7.1     Application**

9.1.7.1.1     This subsection applies to all exhaust systems on all small vessels equipped with inboard or stern drive engines, or permanently installed auxiliary engines.

### **9.1.7.2     General**

9.1.7.2.1     All exhaust systems shall be gastight to the hull interior.

9.1.7.2.2     Every exhaust system fitting, joint, clamp, and support shall be accessible for inspection and repair. All hose connections shall be double clamped.

9.1.7.2.3     Exhaust system piping, components and connection shall be independently supported to minimize failure from vibration, shock and expansion.

9.1.7.2.4     All supports, hangers, brackets, or other fittings in contact with uncooled exhaust carriers shall be non-combustible and constructed so that the temperatures transmitted to the supporting materials will not cause combustion or component failure.

9.1.7.2.5     Exhaust system piping shall be kept at a safe distance from combustible material, so as to prevent the surface temperature of such materials from exceeding 93°C.

9.1.7.2.6     Protective guards, jacketing or covers shall be provided wherever persons or gear might come into contact with the exhaust system where the temperature exceeds 93°C. The temporary removal of this protection is permitted, if necessary for engine maintenance or repair.

9.1.7.2.7     Each exhaust system shall be designed and installed to prevent cooling water, rain water, or raw water from entering the engine through the exhaust system under all normal operating and non-operating conditions.

9.1.7.2.8     No additional discharges other than cooling water shall share the exhaust gas passage.

### **9.1.7.3     Materials**

9.1.7.3.1     Materials used in a marine engine exhaust system shall be resistant to saltwater corrosion, resistant to exhaust products, and galvanically compatible. Non-metallic exhaust system components shall meet the requirements of Underwriters Laboratories UL 1129 or Society of Automotive Engineers Standard SAE J2006.

- 9.1.7.3.2 Threaded pipe and fittings for the engine exhaust shall be at least schedule 80 pipe or equivalent.
- 9.1.7.3.3 Non-metallic exhaust system components shall retain watertight integrity for two (2) minutes after a total loss of cooling water with the engine operating at full power.

### **9.1.8 Steering Systems**

- 9.1.8.1 Every non-pleasure craft shall be fitted with a safe and reliable means of steering that is operable from the control position and capable of maneuvering the non-pleasure craft under normal operating conditions. The steering system shall be protected from obstructions, excessive heat, and mechanical wear.
- 9.1.8.2 If the non-pleasure craft's intended service is in remote areas or where help is not readily available, the non-pleasure craft shall be fitted with a means of emergency steering.
- 9.1.8.3 When a steering gear is fitted with remote control, emergency steering shall be fitted on the non-pleasure craft.
- 9.1.8.4 Emergency steering is not required for:
- (a) non-pleasure craft with multiple screw propulsion with independent control of each screw, if it has been demonstrated during sea trials that the non-pleasure craft can be effectively steered at low speed in this fashion;
  - (b) non-pleasure craft with no rudder fitted, where steering action is obtained by a change of directional setting of the propulsion units, when it has been demonstrated during sea trials that the non-pleasure craft can be effectively steered at low speed in this fashion;
  - (c) non-pleasure craft fitted with a rudder and a hand tiller as the main steering arrangement;
  - (d) non-pleasure craft fitted with independently controlled adjustable trim tabs, when it has been demonstrated during sea trials that the non-pleasure craft can be effectively steered at low speed in this fashion; and
  - (e) non-pleasure craft fitted with a bow thruster, when it has been demonstrated during sea trials that the vessel can be effectively steered at low speed using the thruster only.

## **9.2 Auxiliary Machinery**

### **9.2.1 Bilge Pumping Arrangements**

#### **9.2.1.1 Application**

- 9.2.1.1.1 This section applies in respect of non-pleasure craft.

### 9.2.1.2 General

- 9.2.1.2.1 Every non-pleasure craft shall be provided with a means of pumping or bailing each watertight compartment when the vessel is in its operating condition. The means provided shall be effective when the vessel is upright and when it is heeling up to an angle of 10 degrees.
- 9.2.1.2.2 Every non-pleasure craft over 6 m (19 ft 8 in) in length shall have at least one automatic bilge pump of at least 0.91 L/s (0.25 U.S. gal/sec; 900 U.S. gal/hr) minimum capacity.

### 9.2.1.3 Where a Piping System Is Fitted

- 9.2.1.3.1 The piping arrangement shall ensure that no back siphoning can occur and marine type strainers shall be provided on the suction line from each compartment.
- 9.2.1.3.2 The piping shall be of metal, rigid plastic, non-collapsible and non-oil degradable hose with flanged, screwed, or robust double-clamped connections, where practicable.
- 9.2.1.3.3 The piping shall be not less than 25 mm (1 in) in diameter, except that for small compartments piping 18 mm ( $3/4$  in) in diameter may be acceptable if the pump-out time is under five (5) minutes.
- 9.2.1.3.4 On non-pleasure craft over 6 m (19 ft 8 in) in length that have bilges that are not readily observed, audible bilge alarms or visual indicators shall be provided at the operating station to indicate:
- a high bilge level in a normally unattended machinery space or other space having an underwater through-hull connection; and
  - when an automatic bilge pump is operating.
- 9.2.1.3.5 Where overnight sleeping accommodation is provided, high bilge level alarms shall be audible (84 dBA) to persons sleeping.
- 9.2.1.3.6 Where there are automatic bilge pumping arrangements, they shall be fitted with an overriding manual switch that is readily accessible.

### 9.2.2 Pressure Vessels

- 9.2.2.1 Every pressure vessel shall be fitted with a drain valve, pressure gauge, and safety valve, and shall conform to ASME *Boiler and Pressure Vessel Code*, except for the following:
- a pressure vessel having a working pressure that does not exceed 103 kPa (15 lbs/in<sup>2</sup>);
  - a pressure vessel having an internal diameter that does not exceed 152 mm (6 in);
  - a pressure vessel where the volume above the normal working level of a liquid does not exceed 45 L (12 U.S. gal); or
  - a pressure vessel where the volume does not exceed 150 L (40 U.S. gal) and the maximum working pressure does not exceed 700 kPa (100 lbs/in<sup>2</sup>).

**Section 10.0**

**FIRE PROTECTION SYSTEMS**

**ISSUE NUMBER: 3**

**DATE: 2004 Edition**

**NUMBER OF PAGES: 2**

THIS ISSUE SUPERSEDES

Issue Number: 2

Dated: January 2002

Archived

## 10.1 Application

10.1.1 This section applies in respect of non-pleasure craft only.

## 10.2 General

10.2.1 All inboard power-driven non-pleasure craft with an enclosed engine compartment shall have provisions for discharging an extinguishing agent directly into the space immediately surrounding the engine without opening the primary access. Where portable equipment is provided for use with sufficient quantity of extinguishing agent to flood the engine space, a readily accessible port to the enclosure shall be provided that permits the extinguisher to remain upright during discharge. If the access port cannot be positioned so as to allow the portable extinguisher to remain upright, the portable extinguisher shall be equipped with a discharge hose. The port shall be labeled to promptly bring to the attention of the persons on board its fire fighting purpose.

## 10.3 Means of Escape

10.3.1 A minimum of two (2) means of escape shall be provided for accommodation, service, and machinery spaces. The two (2) means of escape shall be as remote from each other as practicable so as to minimize the possibility of one incident blocking both escapes.

10.3.2 All common spaces having a deck area of over 28 m<sup>2</sup> shall have a minimum of two (2) means of escape; where practicable these exits shall have egress to different rooms or spaces to minimize the possibility of one incident blocking both exits.

10.3.3 One (1) means of escape is acceptable where;

- (a) the space is generally unoccupied; or
- (b) the physical size of the space does not permit two (2) means of escape.

## 10.4 Fire Detection

10.4.1 Smoke and heat rise detectors shall be provided for sleeping quarters, service, and machinery spaces. For the machinery spaces, the fire alarm system shall be hard-wired to the alarm at the control position in accordance with *Marine Electrical Standards*, TP127, section 21.

**10.5 Fire Extinguishing**

- 10.5.1 Spaces protected by a gas smothering system shall be gastight such that leakage of the system will not penetrate accommodation and service spaces.
- 10.5.2 A totally enclosed engine compartment shall be fitted with a fixed fire extinguishing system with sufficient quantity to completely blanket the space. The release device shall be outside of the engine compartment.
- 10.5.3 For carbon dioxide (CO<sub>2</sub>) fixed fire extinguishing systems, the amount of CO<sub>2</sub> shall be 40% of the gross volume of the engine compartment, but not less than 2.25 kg (5 lbs). A minimum of 85% of the total volume shall be released in a maximum of two (2) minutes.
- 10.5.4 The engine compartment shall be equipped with at least two (2) portable CO<sub>2</sub> fire extinguishers, or where it cannot be gastight, dry chemical extinguishers, stored at the entrance of the space. Fire extinguishers shall be a minimum 5 lbs and have a rating of type ABC.
- 10.5.5 Requirements for the size and type of portable fire extinguishers to be carried are to be found in the *Small Vessel Regulations* or the *Fire Detection and Extinguishing Equipment Regulations*, as applicable.

## Appendix 1.0

COMPLIANCE PROCESS AND FORMS FOR MANUFACTURERS AND  
IMPORTERS OF NEW PLEASURE CRAFT

**ISSUE NUMBER:** 3  
**DATE:** 2004 Edition  
**NUMBER OF PAGES:** 19

THIS ISSUE SUPERSEDES  
Issue Number: 2  
Dated: January 2002

Archived

## A1.1 Safety Label Compliance Process for New Pleasure Craft

### PLEASURE CRAFT SAFETY LABEL COMPLIANCE PROCESS FOR MANUFACTURERS AND IMPORTERS OF NEW PLEASURE CRAFT

(for all Pleasure Craft capable of being fitted with an engine)

PLEASE NOTE THAT THE CONSTRUCTION STANDARDS FOR SMALL VESSELS, TP1332, APPLIES TO ALL SMALL VESSELS REGARDLESS OF LENGTH.

If you are a new manufacturer or importer based in Canada (and if the product is not from the United States), you must first apply in writing, on your company's letterhead, to obtain a Manufacturer's Identification Code (MIC) from Transport Canada Marine Safety. A MIC issued by the United States Coast Guard to U.S. manufacturers is recognized in Canada by reciprocal agreement. For completion of the Hull Identification Number, see Section 2.

## A1.2 New Pleasure Crafts Not Exceeding 6 Metres

The following documents and steps must be completed for new pleasure craft not exceeding 6 metres (19 ft 8 in) in length that have not been previously submitted to this office for evaluation and safety rating calculations:

1. The **Statutory Declaration form** (page 101) stating that all models built or imported for use in Canada conform to the pleasure craft requirements of the *Construction Standards for Small Vessels*, TP1332. This declaration form must be completed and signed by a Canadian resident who is a responsible officer or representative of the company, and sworn in front of a person authorized to administer oaths under the laws of Canada or a province. This form should be updated when further models are introduced, a change of address or company change, or when name changes of models occur. This office must be provided with the declaration with the original signatures (a photocopy is not sufficient). In the case of foreign manufacturers, the Canadian responsible officer, dealer or importer (being a Canadian citizen) **must fully complete** the information requested on the *Statutory Declaration* (i.e., name, complete civic address, city, province and postal code of Canadian responsible officer). The MIC (Manufacturer's Identification Code) must also be indicated. This legal document must be filled in ink and must be legible. If the *Statutory Declaration* on page 101 is reproduced, it **must** be on letter-size bond paper and be identical in format and wording.

In the event that you require additional pages to list the models to be declared, white bond paper (no glossy fax paper and no white out) shall be used. These additional pages shall be properly identified with name of company, MIC, and complete civic address. It shall also have the name of the Canadian responsible officer, his/her signature, name and the signature of the person administering the oath, his/her official seal and/or number with expiry date.

The exact name/number of the model indicated on *Statutory Declaration* will match the exact name/number of the model printed on the Compliance Label.

2. The **Small Vessels Information Form for Manufacturers of New Vessels** (page 103) with full details of ALL the models, **REGARDLESS OF LENGTH**, must be provided.
3. Photographs or professional drawings with scale bar and identification bar of all vessels showing side-view parallel to the ground, back view parallel to the ground, and interior of each model showing general arrangement (which includes helm position, storage and motor well). If submitting photos, please clearly identify the company and model names and/or numbers.
4. **Application Forms for Pleasure Craft Capacity Label** (pages 108 and 110, or 115, or 117) must be fully completed.
5. Each model Application package shall be stapled and contain the following:
  - (a) *Small Vessel Information Form for Manufacturers of New Vessels*
  - (b) All Photos of all requested views
  - (c) Two-page (2-page) Application (if 6 metres and less)

#### NOTE

The documents in items 1, 2, 3, and 4 **must be resubmitted** when a change of company ownership, change of company address (location), or model name occurs.

6. **Capacity Label Order Form** (page 119). This form must be **fully** completed as any missing details may cause delays in processing the submission.
7. **Conformity Label Order Form** (page 121). This form must be **fully** completed for vessels evaluated or assessed lower than 7.5 kW or for vessels over 6 m as any missing details may cause delays in processing the submission.
8. Acceptances of Ratings Forms – Ratings for Capacity Labels will be submitted to manufacturers or importers for approval prior to the processing of the labels.
9. Method of Payment: The cost of a label is Can \$5.00 (no tax). Orders of labels (Conformity or Capacity labels) may be paid by credit card (either VISA or MASTERCARD) or invoicing. **Prepayment** by cheque is no longer acceptable. Upon shipment of labels, an invoice is sent to the manufacturer. This invoice is paid by credit card (Visa or MasterCard) or by cheque, made to the order of Receiver General of Canada.

#### NOTE

At least thirty (30) working days should be allowed from the receipt, by this office, of a **fully completed** submission for NEW vessels. Any incomplete or missing documents will be returned and will cause delays in processing.

### A1.3 New Pleasure Craft Exceeding 6 Metres

**The Following Documents and Steps Must Be Completed for New Pleasure Vessels Over 6 Metres (19 ft 8 in) in length and Have Not Been Previously Submitted to This Office For Evaluation and Assessment:**

Please follow steps 1, 2, 3, 5 and 7 (see A1.2); steps 4 and 6 are not required.

#### NOTE

At least thirty (30) working days should be allowed from the receipt, by this office, of a fully completed submission for NEW vessels. Any incomplete or missing documents will be returned and will cause delays in processing.

### A1.4 Ordering Labels (Repeat Orders)

**Procedures for ordering labels for models already evaluated/safety ratings calculated by this office.**

Fully complete the appropriate Order Form indicated in 6 or 7 (A1.2) – depending on the type of label – and provide item 9 (method of payment).

#### NOTE

At least fifteen (15) working days should be allowed from the receipt, by this office, of a fully completed submission for label repeat orders of models not requiring an evaluation. If a model needs to be evaluated, the standard thirty (30) working days should be allowed. Any incomplete or missing documents will be returned and will cause delays in processing.



## STATUTORY DECLARATION / DÉCLARATION STATUTAIRE

I, \_\_\_\_\_,  
Name of Canadian Responsible Officer

Je, soussigné, \_\_\_\_\_,  
Nom de l'agent canadien responsable

\_\_\_\_\_  
Capacity or Title of Responsible Officer

\_\_\_\_\_  
Titre ou qualité de l'agent canadien responsable

of the \_\_\_\_\_  
Name of Canadian Manufacturer or Importer

de \_\_\_\_\_  
Nom du fabricant ou de l'importateur canadien

ADDRESS OF CANADIAN MANUFACTURER OR IMPORTER

ADRESSE DU FABRICANT OU DE L'IMPORTATEUR CANADIEN

Street/Rue	
City/Ville ( ) -	Province ( ) -
Postal Code/Code postale	
Telephone/Téléphone	Facsimile/Télécopieur
E-mail Address (if applicable)/Adresse de courrier électronique (s'il y a lieu)	

do solemnly declare that the boat or boats listed hereunder by model name, name and/or model number are built to comply with the Construction Standards for Small Vessels, TP1332, pleasure craft requirements, as modified from time to time, or as substituted for by equivalent standards issued by Transport Canada. And I make solemn declaration conscientiously believing it to be true and knowing that it is of the same force and effect as if made under oath and by virtue of the Canada Evidence Act.

déclare solennellement que le ou les bâtiments désignés ci-dessous par leur nom ou leur numéro de modèle sont construits conformément aux exigences relatives aux embarcations de plaisance de la Norme de construction des petits bâtiments, TP1332, telle que modifiée à l'occasion ou remplacée par Transports Canada. Je fais cette déclaration solennelle en toute bonne foi et je reconnais qu'elle a la même valeur et les mêmes conséquences que si elle était faite sous serment et en vertu de la Loi sur la preuve au Canada.

Manufacturer's Identification Code

Code d'identification du fabricant

MODEL NAME/MODEL NUMBER – NOM DU MODELE/NUMÉRO DU MODÈLE
--

Name: \_\_\_\_\_  
Canadian Responsible Officer – Please print

Nom : \_\_\_\_\_  
Agent canadien responsable - inscrire en lettres moulées

Signature: \_\_\_\_\_

Signature : \_\_\_\_\_

Declared before me at: \_\_\_\_\_  
Town or City, Province

Déclaré en ma présence le : \_\_\_\_\_  
village ou ville, province

this \_\_\_\_\_ day of \_\_\_\_\_  
Month Year

le \_\_\_\_\_ jour de \_\_\_\_\_  
mois année

\_\_\_\_\_  
Name of Person Authorized to Administer Oaths Under the Laws of Canada or a Province – Please Print

\_\_\_\_\_  
Nom de la personne autorisée à faire prêter serments en vertu des lois du Canada ou d'une province - inscrire en lettres moulées

\_\_\_\_\_  
Signature of Person Authorized to Administer Oaths Under the Laws of Canada or a Province

\_\_\_\_\_  
Signature de la personne autorisée à faire prêter serments en vertu des lois du Canada ou d'une province

\_\_\_\_\_  
Official Seal or Official Number

\_\_\_\_\_  
Sceau officiel ou Numéro officiel

Expiry Date

Date d'expiration



**SMALL VESSELS INFORMATION FORM FOR MANUFACTURERS OF NEW VESSELS**  
**FORMULAIRE D'INFORMATION SUR LES PETITES EMBARCATIONS POUR LES FABRICANTS DE NOUVEAUX BÂTIMENT**

Other or Past Company Name/Autre nom ou ancien nom de l'entreprise	Declaration Date(s) (year/mo/day)/Date(s) de déclaration (année/mo/jour)
Current Company Name/Nom actuel de l'entreprise	Manufacturer's Identification Code/Code d'identification du fabricant

Street/Rue \_\_\_\_\_

City/Ville ( ) - Province ( ) - Postal Code/Code postale \_\_\_\_\_

Telephone/Téléphone \_\_\_\_\_ Facsimile/Télécopieur \_\_\_\_\_

E-mail Address (if applicable)/Adresse de courrier électronique (s'il y a lieu) \_\_\_\_\_

Dimensions should be in metric form. One model name per column (to be inserted in each column). Les dimensions doivent être métriques. Un nom du modèle par colonne (à insérer dans chaque colonne).

<sup>1</sup> See Classification Codes

<sup>1</sup> Voir Codes de Classification

MODEL NAME – NOM DU MODÈLE					
Length Longueur					
Width (beam) Largeur					
Transom Width Largeur du tableau					
Transom Height Hauteur du tableau					
Maximum Load Charge maximale					
Engine Power Puissance du moteur					
Type – Code 1 <sup>1</sup> Type – code 1 <sup>1</sup>					
Material – Code 2 <sup>1</sup> Matériau – code 2 <sup>1</sup>					
Hull – Code 3 <sup>1</sup> Forme de la coque – code 3 <sup>1</sup>					
Engine – Code 4 <sup>1</sup> Moteur – code 4 <sup>1</sup>					
Steering – Code 5 <sup>1</sup> Appareil de gouverne – code 5 <sup>1</sup>					

Notes<sup>2</sup>

MODEL NAME – NOM DU MODÈLE					
Length Longueur					
Width (beam) Largeur					
Transom Width Largeur du tableau					
Transom Height Hauteur du tableau					
Maximum Load Charge maximale					
Engine Power Puissance du moteur					
Type – Code 1 <sup>1</sup> Type – code 1 <sup>1</sup>					
Material – Code 2 <sup>1</sup> Matériau – code 2 <sup>1</sup>					
Hull – Code 3 <sup>1</sup> Forme de la coque – code 3 <sup>1</sup>					
Engine – Code 4 <sup>1</sup> Moteur – code 4 <sup>1</sup>					
Steering – Code 5 <sup>1</sup> Appareil de gouverne – code 5 <sup>1</sup>					

Notes<sup>2</sup>

<sup>2</sup> If imported vessels, list manufacturer name(s) and address(es) and indicate above under "Notes" model manufacturer. Pour les bâtiments importés indiquez le nom et l'adresse des fabricants dans la section « Notes ».

### SMALL VESSELS INFORMATION FORM FOR MANUFACTURERS OF NEW PLEASURE CRAFT – DEFINITIONS

Type, Material, Hull, Engine and Steering Codes: These various codes may be found under Classification Codes, on page 106

<b>Terms</b>	<b>Definitions</b>
<b>Manufacturer's Identification Code (MIC)</b>	The first three characters of the Hull Identification Number.
<b>Current Company Name</b>	The name the company is known by.
<b>Other or Past Company Name</b>	Other names the company may be associated with and/or Past Company Name, or both.
<i>If you are an importer, the makes and models of vessels imported and/or distributed should be specified.</i>	
<b>Length</b>	Length overall on the centre line from the stem post to the stern post or transom.
<b>Width (Beam)</b>	Maximum width.
<b>Transom Height</b>	Height from the bottom edge of the transom to the bottom edge of the motor cutout or to the top of the forward bulkhead of the motor well.
<b>Transom Width</b>	Maximum transom width.
<b>Maximum Load</b>	Maximum load requested by the manufacturer or importer, or ratings already issued by CCG or Transport Canada Marine Safety.
<b>Engine Power</b>	Maximum engine power requested by the manufacturer or importer, or ratings already issued by CCG or Transport Canada Marine Safety.

## CLASSIFICATION CODES – CODES DE CLASSIFICATION

To be used as reference for completion of Small Vessels Information Form for Manufacturers of New Vessels (page 103). / À utiliser comme référence pour compléter le Formulaire d'information sur les petites embarcations fabricants de nouveaux bateaux (page 103).

<b>Vessel Types – Code 1 Types de bateaux – code 1</b>		<b>Hull Material – Code 2 Matériau de coque – code 2</b>		<b>Hull Form – Code 3 Forme de la coque – code 3</b>					
101	Open Vessel – Power Bâtiment non ponté – motorisé	201	Fibreglass – glass reinforced plastic Fibre de verre – plastique renforcé de verre	301	Flat bottom Coque à fond plat				
102	Closed Vessel – Power Bâtiment ponté – motorisé			302	Round bottom Coque à fond arrondi				
103	Open Vessel – Sail Bâtiment non ponté – voile			202	Aluminum Aluminium	303	V-bottom Coque à fond en V		
104	Closed Vessel – Sail Bâtiment ponté – voile			203	Steel Acier	304	Modified V Coque à fond en V modifié		
106	Multihull Bâtiment multicoque			204	Wood Bois	305	Deep V Coque à fond en V profond		
107	Personal Watercraft Motomarine			205	Ferro cement Ferrociment	306	Tunnel hull Coque tunnel		
108	Hovercraft (ACV) Aéroglysieur	220	Other: specify Autre : préciser	307	Tri-hull Coque trimaran				
109	Airboat Hydroglisseur			308	Cathedral hull Coque cathédrale				
110	Inflatable Embarcation pneumatique			309	Catamaran Coque catamaran				
120	Other: specify Autre : préciser			310	Displacement hull Coque à déplacement				
				311	Pontoon Coque ponton				
				320	Other: specify Autre : préciser				
<b>Engine – Code 4 / Moteur – code 4</b>									
401	Inboard gasoline – Moteur en-bord à essence								
402	Inboard diesel – Moteur en-bord à combustion diesel								
403	Inboard LPG/CNG – Moteur en-bord à gaz liquéfié ou à gaz naturel comprimé								
404	Outboard, no motor well – Moteur hors-bord sans puits à moteur								
405	Outboard with motor well – Moteur hors-bord avec puits à moteur								
406G	Inboard-outboard gasoline – Moteur en-bord/hors-bord à essence								
406D	Inboard-outboard diesel – Moteur en-bord/hors-bord à combustible diesel								
407	Sail drive – Propulsion à voile								
408	Electric – Propulsion électrique								
409	Jet drive – Propulsion à réaction								
410	Air drive – Propulsion à air								
420	Other: specify – Autre : préciser								
<b>Steering – Code 5 Commande – code 5</b>									
501	Remote fwd of midships À distance, à l'avant du milieu								
502	Remote aft of midships À distance, à l'arrière du milieu								
503	Outboard tiller arm Bras du gouvernail à l'extérieur								
504	Rudder and tiller Gouvernail et barre de gouvernail								
505	Rudder and wheel Gouvernail et volant								
506	Other: specify Autre : préciser								



## APPLICATION FOR VESSEL CAPACITY LABEL AND MEASUREMENT FORMS (MONOHULLS) DEMANDE D'ÉTIQUETTE DE CAPACITÉ POUR EMBARCATION (MONOCOQUE) ET FORMULAIRE DE MESURES

### INSTRUCTIONS

The purpose of this form is to obtain a series of measurements from which the Department can make calculations to determine the safe load capacity and engine power of the vessel.

The measurements required are the length, widths, and a series of vertical depths at different parts of your vessel. Please refer to additional instructions for taking measurements.

Below the sketches is a section dealing with the hull shape. This has a bearing on the ratings selected. The first question asks whether the vessel has a flat bottom, a hard chine or vee bottom, a round bilge or round bottom or a cathedral-type hull. Pick the one that describes your vessel closely at the mid-length. The next question asks for the NUMBER OF OCCUPANT POSITIONS. If your craft HAS a motor well, insert the dimensions in the next box. The last question asks whether or not your vessel has a steering wheel and motor controls and if they are located forward of Section 'C', as well as the dry weight of vessel in kilograms; these conditions have considerable bearing on the way a vessel handles under power, and on the recommended maximum engine power.

If further information is required, or to return the documents, please use the address below:

Transport Canada – Marine Safety  
Office of Boating Safety (AMSRO)  
Tower C, Place de Ville  
11th Floor  
330 Sparks Street  
Ottawa, ON  
Canada  
K1A 0N8

Telephone: 1-800-267-6687  
Facsimile: (613) 991-4818

Donnez toutes les mesures et les autres renseignements demandés dans le présent formulaire, et expédiez le tout par la poste à l'adresse cidessous, en incluant les photos/illustrations en incluant les photos et illustrations professionnelles, démontrant l'échelle et l'identification de tous les modèles, avec vues latérales, arrières (prises parallèle au sol) et intérieure de chacun d'entre eux (ce qui inclus la position du gouvernail, l'entreposage et le puit de moteur). Si des photos sont envoyées, identifier clairement les noms de l'entreprise et les noms et/ou numéros des modèles.

Le présent formulaire vise à recueillir un certain nombre de mesures dont se servira le Ministère pour faire les calculs qui lui permettront de déterminer le volume de votre embarcation sous le plan de flottaison statique, et de recommander la charge brute et la puissance qui lui conviennent.

Les mesures demandées sont la longueur, les largeurs et une gamme de hauteurs mesurées à différents points de votre embarcation. Veuillez référer aux instructions additionnelles pour mesurer les dimensions. L'espace réservé aux croquis est suivi d'une section relative à la forme de la coque. Celle-ci situe votre embarcation dans l'une ou l'autre des catégories établies. C'est pourquoi on vous demande d'abord si votre embarcation est à fond plat, à bouchains vifs ou à fond en « V », à bouchains, à fond arrondi ou de type cathédrale. Cochez la réponse qui correspond le plus à votre embarcation à mi-longueur. ON VOUS DEMANDE ENSUITE LE NOMBRE DE PLACES POUR LES OCCUPANTS. Si votre embarcation est dotée d'un puits à moteur, inscrivez les dimensions de ce dernier dans la case suivante. On vous demande enfin si votre embarcation est munie d'un volant et de commandes de moteur et s'ils sont situés en avant de la section « C », et le poids sec du bateau en kilogrammes. Cela a une importance énorme sur la conduite d'une embarcation à moteur en marche et sur la puissance motrice maximale qui sera recommandée.

Si vous avez besoin de renseignements additionnels, ou pour acheminer les documents, adressez-vous au :

Transports Canada – Sécurité Maritime  
Bureau de la sécurité nautique (AMSRO)  
Tour C, Place de Ville  
11<sup>ème</sup> étage  
330 rue Sparks  
Ottawa (Ontario)  
Canada  
K1A 0N8

Téléphone : 1-800-267-6687  
Télécopieur : (613) 991-4818



## APPLICATION FOR VESSEL CAPACITY LABEL (MONOHULLS) DEMANDE D'ÉTIQUETTE DE CAPACITÉ POUR EMBARCATION (MONOCOQUE)

PRINT YOUR NAME AND MAILING ADDRESS IN BOX BELOW  
DANS LE CADRE CI-DESSOUS, ÉCRIVEZ VOTRE NOM ET VOTRE ADRESSE EN LETTRES MOULÉES

Street/Rue		
City/Ville ( )	Province ( )	Postal Code/Code postale -
Telephone/Téléphone		Facsimile/Télécopieur
E-mail Address (if applicable)/Adresse de courrier électronique (s'il y a lieu)		

**ALL MEASUREMENTS  
TO BE IN MILLIMETRES**  
**TOUTES LES MESURES  
DOIVENT ÊTRE EN  
MILLIMÈTRES**

Model of vessel/Modèle d'embarcation (if applicable/s'il y a lieu)	Manufacturer's name or if homebuilt/Nom du fabricant ou construction domestique
Year built and manufacturer's identification code (if applicable)/Année de construction et code d'identification du fabricant (s'il y a lieu)	

CHECK THE SKETCH WHICH MOST CLOSELY RESEMBLES YOUR VESSEL  
It is not possible to depict all types vessels; if you cannot find an illustration below that resembles your vessel, describe it in your own words or attach any literature that describes the vessel.

PARMI LES CROQUIS CI-DESSOUS, CHOISISSEZ CELUI QUI RESSEMBLE LE PLUS À VOTRE EMBARCATION  
Si votre modèle n'est pas représenté ci-dessous, veuillez le décrire dans vos propres mots ou inclure un document le décrivant.



<p><b>BOTTOM CONTOUR - FOND</b></p> <p><input type="checkbox"/> Is your vessel flat bottom? Votre embarcation est-elle à fond plat?</p> <p><input type="checkbox"/> Hard chine or V bottom? À bouchains vifs ou à fond en « V »?</p> <p><input type="checkbox"/> Round bilge or round bottom? À bouchains ou à fond arrondi?</p> <p><input type="checkbox"/> Cathedral type? Style cathédral?</p>	<p>Number of permanent occupant positions on board</p> <p>Nombre de places permanentes pour les occupants à bord</p> <div style="border: 1px solid black; width: 40px; height: 20px; margin: 0 auto;"></div>	<p><b>MOTOR WELL dimensions</b> Dimensions du PUIT À MOTEUR</p> <p>Length Longueur <input style="width: 60px;" type="text"/></p> <p>Breadth Largeur <input style="width: 60px;" type="text"/></p> <p>Mean depth Profondeur moyenne <input style="width: 60px;" type="text"/></p>	<p>Does your vessel have a steering wheel and motor control? <input type="checkbox"/> Yes / Oui <input type="checkbox"/> No / Non</p> <p>Votre embarcation est-elle munie d'un volant et de commandes de moteur?</p> <hr/> <p>Steering control located forward of section C? <input type="checkbox"/> Yes / Oui <input type="checkbox"/> No / Non</p> <p>Commande de direction située en avant de la section C?</p>
---	--	--	---

<p>Dry weight of vessel <b>in kilograms</b> (includes all permanent structure and deck, railings, console, cabin, seats) If the vessel is powered by an outboard engine do not include engine and equipment or portable fuel tank weights. For all other types of power vessels, the engine weight is to be included in the vessel weight.</p> <p>Le poids sec du bâtiment <b>en kilogrammes</b> (incluant toute structure permanente et le pont, les garde-corps, la console, la cabine et les sièges.) Si le bateau est équipé d'un moteur hors-bord, le poids comprend le poids de l'équipement et du réservoir de carburant portatif. Pour tous les autres types de moteur le poids du moteur doit être inclus dans le poids du bateau.</p>	kg
---	----

You are required to submit photos or professional Illustrations, of all vessels – including scale bar and identification – showing side-view parallel to the ground, back view parallel to the ground, and interior of each model showing general arrangement (which includes helm position, storage and motor well). If submitting photos, please clear identify the company and model names and/or number, and inboard location for all persons to be carried.

It is the responsibility of the vessel builder and owner to ensure that the vessel complies with the *Construction Standards for Small Vessels – TP1332*. Outboard motors mounted on the transom or transom brackets, are to be installed in such a way that their movement is not restricted by any part of the vessel's structure and there is to be sufficient clearance between the vessel's structure and the outboard motor in all positions that would allow for the free movement of a person's arm.

Donnez toutes les mesures et les autres renseignements demandés dans le présent formulaire, et expédiez le tout par la poste à l'adresse ci-dessous, en incluant les photos ou illustrations professionnelles, démontrant l'échelle et l'identification de tous les modèles, avec vues latérales, arrières (prises parallèle au sol) et intérieure de chacun d'entre eux (ce qui inclus la position du gouvernail, l'entreposage et le puit de moteur). Si des photos sont envoyées, identifier clairement les noms de l'entreprise et les noms et/ou numéros des modèles.

Il incombe au fabricant et au propriétaire de l'embarcation de s'assurer que celle-ci est conforme aux *Normes de construction des petits bateaux – TP1332*. Les moteurs hors-bord montés sur le tableau ou sur des supports arrière doivent être installés de façon à ce qu'aucune partie de l'embarcation n'entrave leur mouvement. Il doit y avoir suffisamment de jeu entre la structure de l'embarcation et le moteur hors-bord, dans toutes les positions, pour qu'une personne puisse y passer librement le bras.



**APPLICATION FOR VESSEL CAPACITY LABEL (MONOHULLS)**  
**DEMANDE D'ÉTIQUETTE DE CAPACITÉ POUR EMBARCATION (MONOCOQUE)**

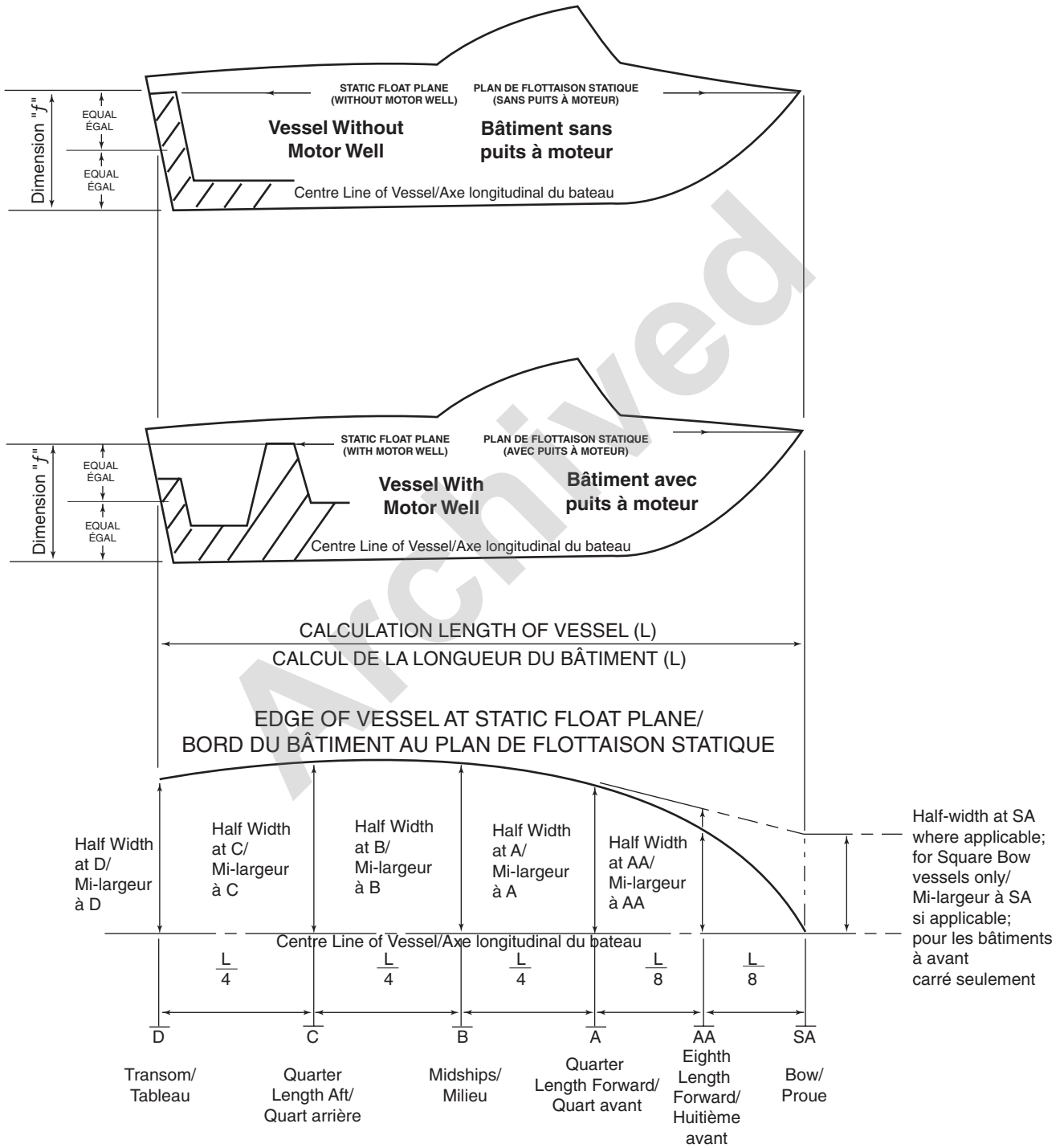



**APPLICATION FOR VESSEL CAPACITY LABEL (MONOHULLS)  
DEMANDE D'ÉTIQUETTE DE CAPACITÉ POUR EMBARICATION (MONOCOQUE)  
ALL MEASUREMENTS TO BE IN MILLIMETRES/TOUTES LES DIMENSIONS DOIVENT ÊTRE EN MILLIMÈTRES**

<sup>1</sup> Name of Canadian Manufacturer or Importer/Nom du fabricant ou de l'importateur canadien	Name/Model Number – Nom/Numéro du modèle
--	--

<sup>1</sup>Names as per the Statutory Declaration information/Noms dans Déclaration Statutaire

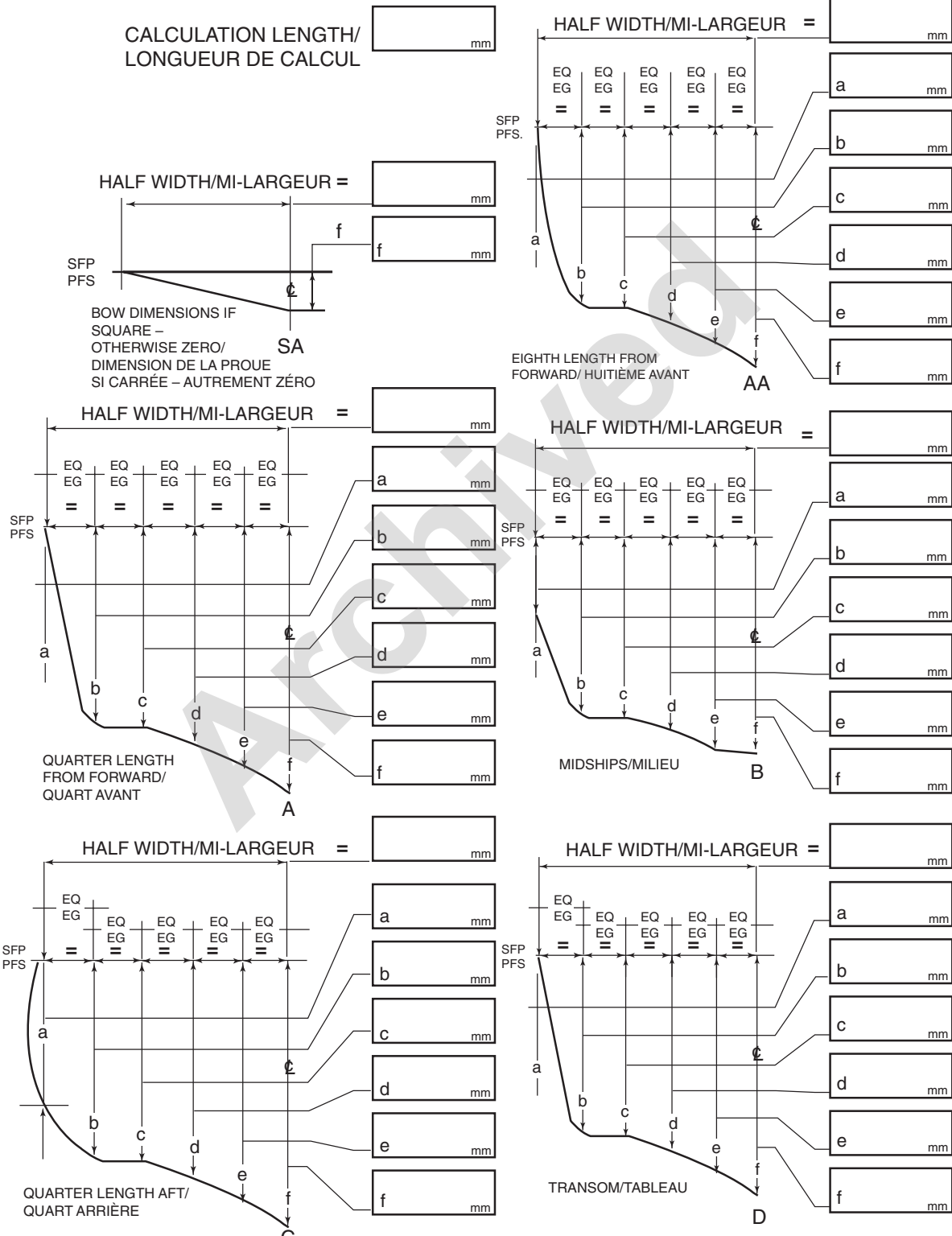

NOTE: Dimension 'a' on half sections AA, A, B, C, and D, will be zero unless the hull topside down from the Static Float Plane is vertical or lays outward.  
 NOTA : La dimension «a» aux sous-sections AA, A, B, C et D sera de zéro, à moins que la coque inversée depuis le plan de flottaison statique soit verticale ou qu'elle repose vers l'extérieur.

### A1.5 Instructions for Measuring Monohull Vessels (Long Method)

Two options exist for measuring a small vessel for a capacity rating. A Short Method (for Single Vessel Label Applications only – See Appendix 2). A Long Method (for Manufacturers and Importers, and Single Vessel Label applications, if required).

The Short Method involves providing only five (5) measurements, and may result in a rating slightly less than a rating derived from the Long Method. The Long Method involves providing up to thirty-eight (38) measurements.

The following measurement instructions are intended as a guide. Both methods require the same initial preparation. The Static Float Plane represents the deepest waterline to which a small vessel could be immersed without water entering over the sides and ends.

#### Preparation

1. On smooth level surface, mark a straight line (Centre Line of the vessel) approximately 1 m (3 ft) longer than the vessel. This line is represented by [1] in Figure A1-2.
2. Mark a second line parallel to the Centre Line a distance away of approximately half the width of the small vessel plus 300 mm (1 ft). This line is represented by [2] in Figure A1-2.
3. Place the small vessel so that the centre of the bow and stern are over the Centre Line that is marked on the ground.
4. Arrange the small vessel so that the Static Float Plane is level (parallel to the flat reference surface). Measure and record the height (H) of the Static Float Plane from that surface.

**Figure A1-1 Monohull Vessel Measurement**

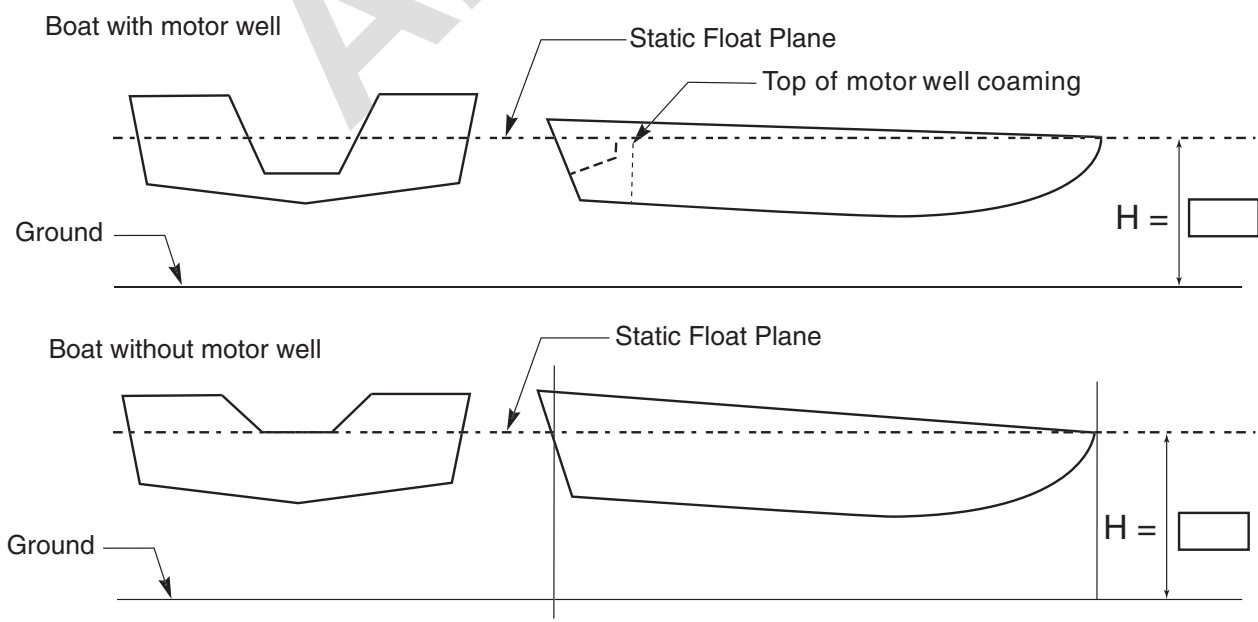

**Long Method [All dimensions on Page 110 must be completed]**

1. With a plumb bob mark the bow and stern on the Centre line [1].
2. Mark a section line [SA] at the bow at right angles to lines [1] and [2].
3. Mark a section line [D] at the stern at right angles to lines [1] and [2].
4. Measure and record the distance L between section lines [SA] and [D].
5. At the mid point between section lines [SA] and [D] mark a section line [B], at right angles to lines [1] and [2].
6. At the mid point between section lines [B] and [D] mark a section line [C], at right angles to lines [1] and [2].
7. At the mid point between section lines [SA] and [B] mark a section line [A], at right angles to lines [1] and [2].
8. At the mid point between section lines [SA] and [A] mark a section line [AA], at right angles to lines [1] and [2].

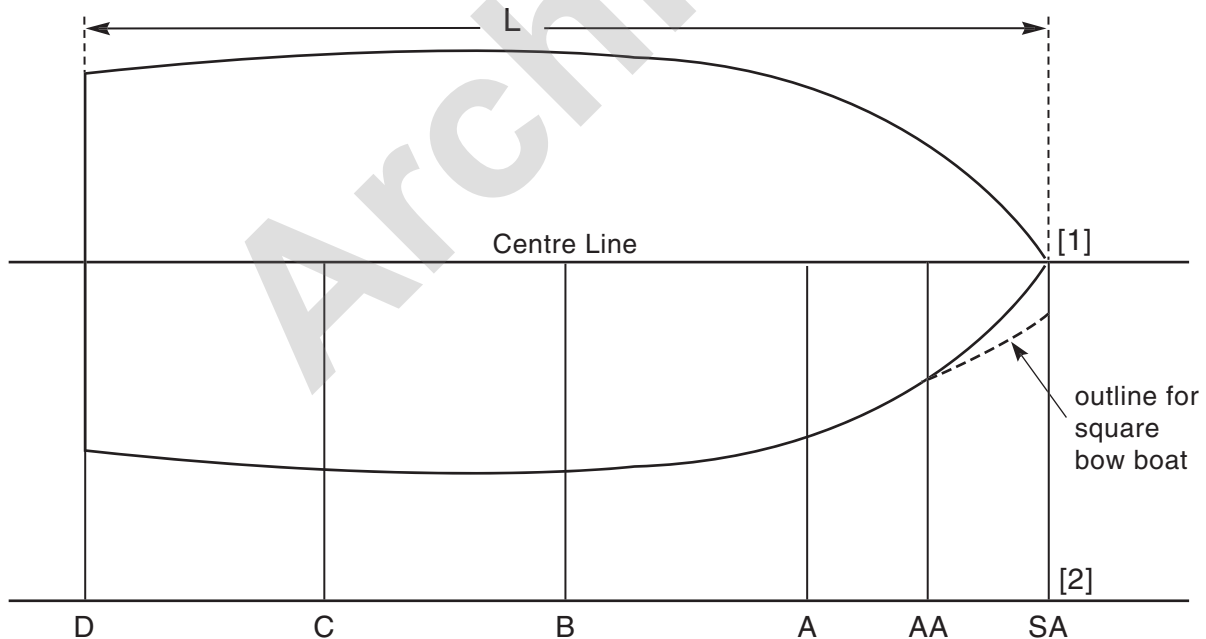
**Figure A1-2 Sectional Half-Beam Measurement**

9. At each section line, drop a plumb line down from the edge of the vessel and mark an X for the outline of the small vessel.

- The distance from X to the line [1] is the half beam, or half width at that particular section. Measure the half beam for each section and record the value on page 110.

**Figure A1-3 A Typical Half Section (AA, A, B, C, D) of the Vessel**

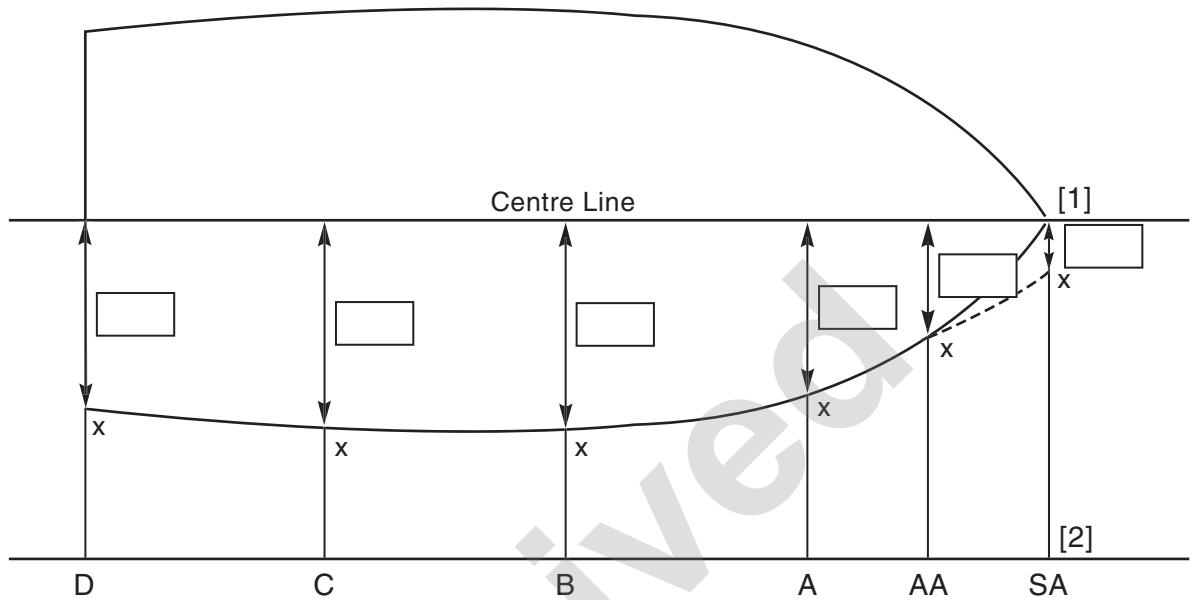

- Divide each section into five equal portions between X and line [1]. A typical half section (AA, A, B, C, D) of the vessel is illustrated.

**Figure A1-4 Measurement of Vessel Depth**

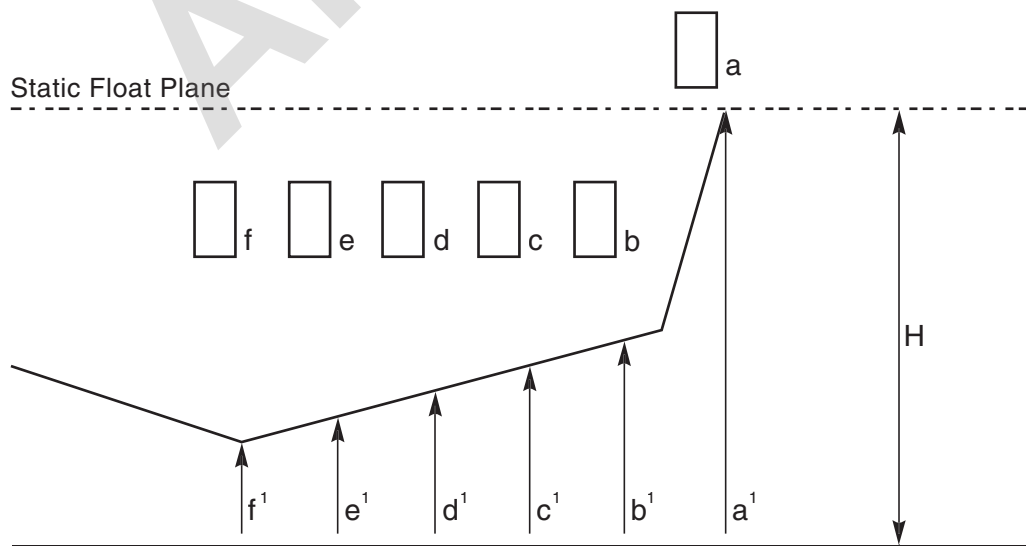

12. To calculate the depths of the small vessel (a, b, d, e, and f), measure up from the ground to the underside of the vessel and deduct the value from H (height of the Static Float Plane above ground).

$$a = H - a^1 \text{ (often zero)}$$

$$d = H - d^1$$

$$b = H - b^1$$

$$e = H - e^1$$

$$c = H - c^1$$

$$f = H - f^1$$

- 13 Repeat this process at each section (SA if applicable), AA, A, B, C, D, and record results on page 110.

Archived



## APPLICATION FOR MULTIHULL VESSEL CAPACITY LABEL DEMANDE D'ÉTIQUETTE DE CAPACITÉ POUR BÂTIMENTS MULTICOQUES

PRINT YOUR NAME AND MAILING ADDRESS IN BOX BELOW  
DANS LE CADRE CI-DESSOUS, ÉCRIVEZ VOTRE NOM ET VOTRE ADRESSE EN LETTRES MOULÉES

\_\_\_\_\_

\_\_\_\_\_

\_\_\_\_\_

**ALL MEASUREMENTS TO  
BE IN MILLIMETRES**

**TOUTES LES MESURES  
DOIVENT ÊTRE EN  
MILLIMÈTRES**

Telephone/Téléphone \_\_\_\_\_ Facsimile/Télocopieur \_\_\_\_\_

**It is necessary that the following information be provided when applying for a capacity label for multihull vessels. Fournir tous les renseignements pour obtenir une étiquette de capacité pour embarcation multicoque.**

Name/Model Number – Nom/Numéro du modèle	Model Year/Année du modèle
--	----------------------------

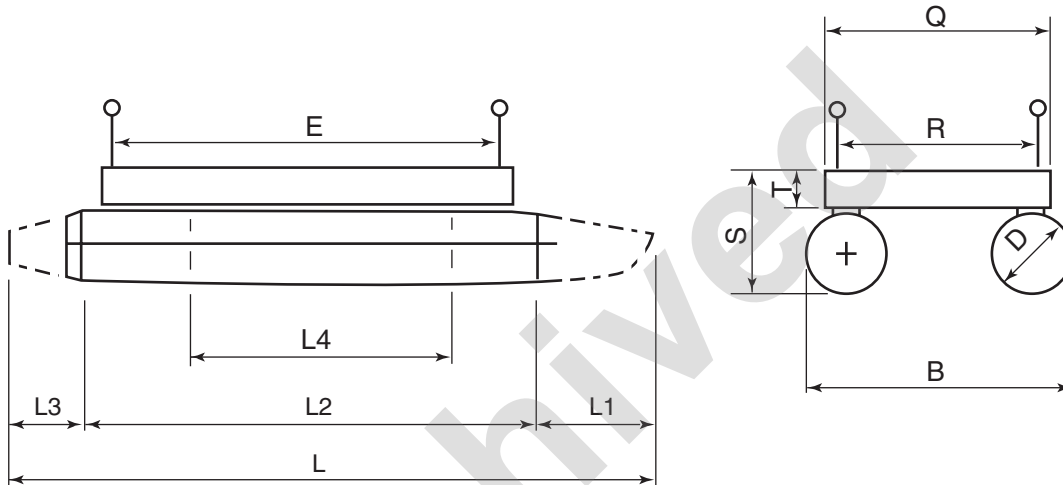

**ALL MEASUREMENTS TO BE IN MILLIMETRES/TOUTES LES MESURES DOIVENT ÊTRE EN MILLIMÈTRES**

LENGTH - LONGUEUR								
Overall/Hors tout	L	mm	Irregular section forward (if any) Partie avant de forme irrégulière (s'il y a lieu)	L1	mm	Parallel section/Partie parallèle	L2	mm
Irregular section aft (if any) Partie arrière de forme irrégulière (s'il y a lieu)	L3	mm	Longest space between two watertight bulkheads in any part of the pontoon (that is not foam-filled.)			Espace le plus long entre deux cloisons étanches dans n'importe quelle partie du flotteur (qui n'est pas rempli de mousse)	L4	mm

WIDTH - LARGEUR	
Maximum/Maximale	B
	mm

Diameter (external; If pontoons are not circular in cross-section, use the diameter of the largest circle that can be inscribed in the pontoon)- Diamètre (extérieur; Si les flotteurs ne sont pas circulaires, donner le diamètre du plus grand cercle qui pourrait être tracé à l'intérieur du flotteur)	D
	mm

DECK - PONT			
Length Between Railings Longueur entre les garde-corps	E	mm	Width Overall Largeur hors tout
			Q
			mm
Height Above Bottom of pontoons Hauteur à partir du fond des flotteurs	S	mm	Depth Profondeur
			T
			mm

Dry weight of vessel in kilograms including: pontoons, deck, railings, console, cabin, seats and any other permanent structure or fittings (Do not include engine and equipment or portable fuel tank). Le poids sec du bateau en kilogrammes, incluant les flotteurs, le pont, les garde-corps, la console, la cabine, les sièges et toute autre structure permanente ou accessoires (ne pas inclure le moteur et l'équipement connexe ou le réservoir de carburant portatif).	kg
--	----

**NOTES**  
The rating of pontoon vessels is to be in accordance with the *Construction Standards for Small Vessels – TP1332*

Please provide 4 photographs showing stern view, side view, front view (taken parallel to the ground) and the seating layout, inside the vessel.

**NOTA**  
La classification des bâtiments pontons doit se faire conformément aux *Normes de construction des petits bateaux – TP1332*.

Prière de fournir 4 photographies montrant une vue latérale, arrière, de l'avant (prises parallèle au sol) et le plan des sièges à l'intérieur.

Signature of Applicant - Signature du demandeur	Date (Year/Month/Day – Année/Mois/Jour)
---	---



## APPLICATION FOR INFLATABLE CRAFT CAPACITY LABEL DEMANDE D'ÉTIQUETTE DE CAPACITÉ POUR EMBARcation PNEUMATIQUE

PRINT YOUR NAME AND MAILING ADDRESS IN BOX BELOW  
DANS LE CADRE CI-DESSOUS, ÉCRIVEZ VOTRE NOM ET VOTRE ADRESSE EN LETTRES MOULÉES

\_\_\_\_\_

\_\_\_\_\_

\_\_\_\_\_

**ALL MEASUREMENTS TO  
BE IN MILLIMETRES**

**TOUTES LES MESURES  
DOIVENT ÊTRE EN  
MILLIMÈTRES**

Telephone/Téléphone

Facsimile/Télocopieur

It is necessary that the following information be provided when applying for a capacity label for inflatable crafts.

Fournir tous les renseignements pour obtenir une étiquette de capacité pour embarcation pneumatique.

Name/Model Number – Nom/Numéro du modèle	Model Year/Année du modèle
--	----------------------------

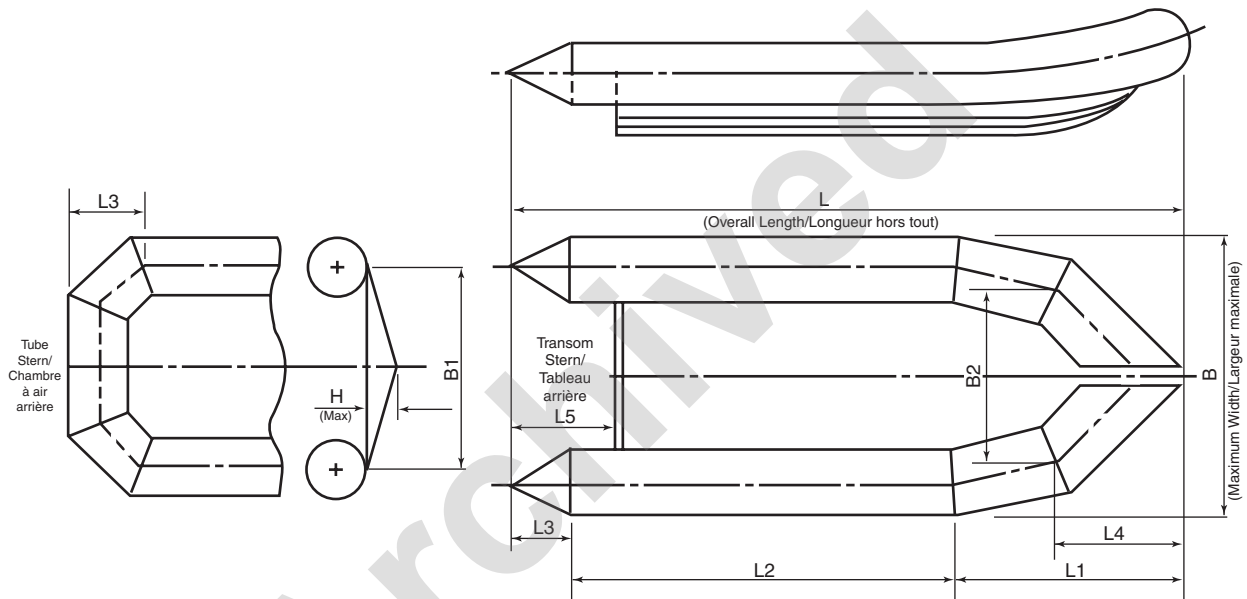

**ALL MEASUREMENTS TO BE IN MILLIMETRES/TOUTES LES MESURES DOIVENT ÊTRE EN MILLIMÈTRES**

LENGTH - LONGUEUR						
L	L1	L2	L3	L4	L5	
mm	mm	mm	mm	mm	mm	mm

WIDTH - LARGEUR					
B	B1	B2	H (max)	Average Diameter of Tube Collar Diamètre moyen de la chambre pneumatique	D
mm	mm	mm	mm	mm	mm

Weight of Vessel in Kilograms (Do not include engine and equipment or portable fuel tank) Le poids du bateau en kilogrammes (ne pas inclure le moteur et l'équipement connexe, ou le réservoir à carburant portatif)	W
	kg

Stern Type - Type d'arrière		Bottom - Fond		Collar - Collier		Steering - Gouvernail		Forward of/ Avant de L/4
Transom À tableau	Tube À chambre	Soft Souple	Rigid Rigide	Inflatable Pneumatique	Rigid Rigide	Tiller Barre franche	Remote À distance	

Number of Buoyancy Chambers Nombre de chambres de flottaison	
---	--

Please provide 4 photographs showing stern view, side view, front view (taken parallel to the ground) and the seating layout, inside the vessel. Prière de fournir 4 photographies montrant une vue latérale, arrière, de l'avant (prises parallèle au sol) et le plan des sièges à l'intérieur.

Signature of Applicant/Signature du demandeur	Date (Year/Month/Day – Année/Mois/Jour)
---	---



## CAPACITY LABEL ORDER FORM BON DE COMMANDE POUR LES ÉTIQUETTES DE CAPACITÉ

**FORWARD ORDERS TO / ENVOYER LES BONS DE COMMANDE À :**

Transport Canada, Marine Safety (AMSRO)  
330 Sparks Street, Ottawa, ON K1A 0N8

Transports Canada, Sécurité Maritime (AMSRO)  
330, rue Sparks, Ottawa, ON K1A 0N8

Fax: (613) 991-4818

Ordered by Commandé par	Last Name/Nom	First Name/Prénom
Company Name Nom de entreprise		Manufacturer's Identification Code/Code d'identification du fabricant
Company P.O. #/Reference No. Numéro de B.C. / Numéro de référence		

PRINT YOUR NAME, MAILING ADDRESS AND OTHER PERTINENT INFORMATION BELOW  
ÉCRIVEZ VOTRE NOM ET VOTRE ADRESSE EN LETTRES MOULÉES CI-DESSOUS

Street/Rue \_\_\_\_\_

City/Ville (     )     –     Province (     )     –     Postal Code/Code postale \_\_\_\_\_

Telephone/Téléphone \_\_\_\_\_ Facsimile/Télocopieur \_\_\_\_\_

E-mail Address (if applicable)/Adresse de courrier électronique (s'il y a lieu) \_\_\_\_\_

PLEASE SUPPLY LABELS FOR MODEL(S) LISTED BELOW.  
VEUILLEZ ME FAIRE PARVENIR DES ÉTIQUETTES POUR CHACUN DES MODÈLES DE BATEAU CI-DESSOUS.

Model Name Nom du modèle	Model Number No. du modèle	Quantity Quantité	Statutory Declaration Date (for each model) Date du Déclaration Statutaire (pour chaque modèle)
			Year/Month/Day – Année/Mois/Jour
			Year/Month/Day – Année/Mois/Jour
			Year/Month/Day – Année/Mois/Jour
			Year/Month/Day – Année/Mois/Jour
			Year/Month/Day – Année/Mois/Jour
			Year/Month/Day – Année/Mois/Jour

Signature of Applicant/Signature du demandeur	Date (Year/Month/Day – Année/Mois/Jour)
---	---



## CONFORMITY LABEL ORDER FORM BON DE COMMANDE POUR LES ÉTIQUETTES DE CONFORMITÉ

### FORWARD ORDERS TO / ENVOYER LES BONS DE COMMANDE À :

Transport Canada, Marine Safety (AMSRO)  
330 Sparks Street, Ottawa, ON K1A 0N8

Transports Canada, Sécurité Maritime (AMSRO)  
330, rue Sparks, Ottawa, ON K1A 0N8

Fax: (613) 991-4818

Ordered by Commandé par	Last Name/Nom	First Name/Prénom
Company Name Nom de entreprise		Manufacturer's Identification Code/Code d'identification du fabricant
Company P.O. #/Reference No. Numéro de B.C./ Numéro de référence		

PRINT YOUR NAME, MAILING ADDRESS AND OTHER PERTINENT INFORMATION BELOW  
ÉCRIVEZ VOTRE NOM ET VOTRE ADRESSE EN LETTRES MOULÉES CI-DESSOUS

Street/Rue \_\_\_\_\_

City/Ville (     )     –     Province (     )     –     Postal Code/Code postale \_\_\_\_\_

Telephone/Téléphone \_\_\_\_\_ Facsimile/Télécopieur \_\_\_\_\_

E-mail Address (if applicable)/Adresse de courrier électronique (s'il y a lieu) \_\_\_\_\_

PLEASE SUPPLY LABELS FOR MODEL(S) LISTED BELOW.  
VEUILLEZ ME FAIRE PARVENIR DES ÉTIQUETTES POUR CHACUN DES MODÈLES DE BATEAU CI-DESSOUS.

Model Name Nom du modèle	Model Number No. du modèle	Quantity Quantité	Statutory Declaration Date (for each model) Date du Déclaration Statutaire (pour chaque modèle)
			Year/Month/Day – Année/Mois/Jour
			Year/Month/Day – Année/Mois/Jour
			Year/Month/Day – Année/Mois/Jour
			Year/Month/Day – Année/Mois/Jour
			Year/Month/Day – Année/Mois/Jour
			Year/Month/Day – Année/Mois/Jour

Signature of Applicant/Signature du demandeur	Date (Year/Month/Day – Année/Mois/Jour)
---	---

## Appendix 2.0

COMPLIANCE PROCESS AND FORMS FOR PLEASURE CRAFT OWNERS AND  
BROKERS OF SECOND-HAND PLEASURE CRAFT

**ISSUE NUMBER: 3**  
**DATE: 2004 Edition**  
**NUMBER OF PAGES: 7**

THIS ISSUE SUPERSEDES  
Issue Number: 2  
Dated: January 2002

Archived

## A2.1

**Pleasure Craft Safety Label Compliance Process for Pleasure Craft Owners and Brokers of Second-Hand Vessels, Regardless of Length**

SINGLE VESSEL LABELS are issued to pleasure craft owners and brokers of second-hand pleasure crafts capable of being fitted with a propulsion engine. This applies to HOMEBUILT pleasure craft and pleasure craft where a manufacturer is unable to issue a compliance label.

The attached INFORMATION PACKAGE includes:

1. The *Construction Standards for Small Vessels*, TP1332;
2. The *Single Vessel Data Sheet* (FOR ALL PLEASURE CRAFT, REGARDLESS OF LENGTH);
3. Application forms [for vessels less than 6 m in length] for monohull vessels (Short Method), multihull (pontoon) vessels, and inflatable crafts.

**The following items and information are to be returned to:**

Transport Canada – Marine Safety  
Office of Boating Safety (AMSRO)  
Tower C, Place de Ville  
11th Floor  
330 Sparks Street  
Ottawa, ON  
Canada  
K1A 0N8

Telephone: 1-800-267-6687

Facsimile: (613) 991-4818

1. The Single Vessel Data Sheet (pages 127 and 129) with overall details of the vessel to be issued with a label), for all pleasure craft including sailboats, REGARDLESS OF LENGTH.
2. Photographs of the actual vessel showing a stern view, side view, bow view, and the seating layout inside of the pleasure craft – REGARDLESS OF LENGTH.

Brochure pictures and hand-drawings are NOT ACCEPTABLE.

3. The cost of the label (CAN \$5.00 per label/one label per vessel), prepaid and made payable to the Receiver General of Canada (personal cheque or money order only).
4. The Application Form for pleasure craft not over 6 metres in length for one of either
  - (a) monohull vessels (short method), see page 131, or
  - (b) multihull (pontoon vessels), see page 133, or
  - (c) inflatable crafts, see page 135.

The details from the appropriate form will be used in the calculations to determine the recommended safe maximum load, number of person allowed on board and only for outboard driven pleasure craft, the recommended maximum power. These safe limits will be printed on the label.

#### **IMPORTANT NOTE**

For monohull pleasure craft not exceeding 6 m (19 ft 8 in) in length, applicants have the option of using the Short Method as illustrated in this Appendix (2.0) or the “Long Method” as illustrated in Appendix 1.0 under the “Capacity Label for Manufacturers.” The difference between the two methods is that the Short Method in this Appendix will give slightly lower ratings than the “Long Method” in Appendix 1.0.

An exemption Letter valid for one year will be issued to applicants for all fully completed applications. Omission of any of the requested data will cause a delay in the issuance of the exemption letter and the processing of the application.

Archived



## SINGLE VESSEL DATA SHEET / FEUILLE DE DONNÉES POUR BATEAU HORS SÉRIE

### Homebuilt Vessels and Vessels Where the Manufacturer Is Unable to Provide a Label Bâtiments de fabrication artisanale et bâtiments dont le fabricant ne peut fournir une étiquette de conformité

PRINT YOUR NAME AND MAILING ADDRESS IN BOX BELOW  
DANS LE CADRE CI-DESSOUS, ÉCRIVEZ VOTRE NOM ET VOTRE ADRESSE EN LETTRES MOULÉES

Name/Nom		
Street/Rue		
City/ville (     )	Province (     )	Postal Code/Code postale
Telephone/Téléphone	Facsimile/Télécopieur	
E-mail Address (if applicable)/Adresse de courrier électronique (s'il y a lieu)		

Name/Model Number - Nom/Numéro du modèle	Model Year - Année du modèle
Name of Builder or Importer/Nom du fabricant ou importateur	
Name of Vessel (if applicable)/Nom du bâtiment (si applicable)	
Length of Vessel (in metres) Longueur du bâtiment (en mètres)	m
Signature of Applicant - Signature du demandeur	Date (Year/Month/Day - Année/Mois/Jour)

## CLASSIFICATION CODES – CODES DE CLASSIFICATION

Classification codes (one of each to be checked off) / Codes de classification (cocher ce qui convient)

<b>Vessel Types – Code 1</b> <b>Types de bateaux – code 1</b>			<b>Hull Material – Code 2</b> <b>Matériau de coque – code 2</b>			<b>Hull Form – Code 3</b> <b>Forme de la coque – code 3</b>		
101	Open Vessel – Power Bâtiment non ponté – motorisé		201	Fibreglass – glass reinforced plastic Fibre de verre - plastique renforcé de verre		301	Flat bottom Coque à fond plat	
102	Closed Vessel – Power Bâtiment ponté – motorisé		202	Aluminum Aluminium		302	Round bottom Coque à fond arrondi	
103	Open Vessel – Sail Bâtiment non ponté – voile		203	Steel Acier		303	V-bottom Coque à fond en V	
104	Closed Vessel – Sail Bâtiment ponté – voile		204	Wood Bois		304	Modified V Coque à fond en V modifié	
106	Multihull Bâtiment multicoque		205	Ferro cement Ferrociment		305	Deep V Coque à fond en V profond	
107	Personal Watercraft Motomarine		220	Other: specify Autre : préciser		306	Tunnel hull Coque tunnel	
108	Hovercraft (ACV) Aéroglisser					307	Tri-hull Coque trimaran	
109	Airboat Hydroglisseur					308	Cathedral hull Coque cathédrale	
110	Inflatable Embarcation pneumatique					309	Catamaran Coque catamaran	
120	Other: specify Autre : préciser					310	Displacement hull Coque à déplacement	
						311	Pontoon Coque ponton	
						320	Other: specify Autre : préciser	
<b>Engine – Code 4 / Moteur – code 4</b>						<b>Steering – Code 5</b> <b>Commande – code 5</b>		
401	Inboard gasoline – Moteur en-bord à essence		501	Remote fwd of midships À distance, à l'avant du milieu		502	Remote aft of midships À distance, à l'arrière du milieu	
402	Inboard diesel – Moteur en-bord à combustion diesel		503	Outboard tiller arm Bras du gouvernail à l'extérieur		504	Rudder and tiller Gouvernail et barre de gouvernail	
403	Inboard LPG/CNG – Moteur en-bord à gaz liquéfié ou à gaz naturel comprimé		505	Rudder and wheel Gouvernail et volant		506	Other: specify Autre : préciser	
404	Outboard, no motor well – Moteur hors-bord sans puits à moteur							
405	Outboard with motor well – Moteur hors-bord avec puits à moteur							
406G	Inboard-outboard gasoline – Moteur en-bord/hors-bord à essence							
406D	Inboard-outboard diesel – Moteur en-bord/hors-bord à combustible diesel							
407	Sail drive – Propulsion à voile							
408	Electric – Propulsion électrique							
409	Jet drive – Propulsion à réaction							
410	Air drive – Propulsion à air							
420	Other: specify – Autre : préciser							



**APPLICATION FOR SINGLE VESSEL LABEL FOR MONOHULL VESSELS  
UNDER 6 METRES (19 ft 8 in) IN LENGTH/  
DEMANDE D'ÉTIQUETTE POUR EMBARCATION MONOCOQUE HORS SÉRIE  
DE MOINS DE 6 MÈTRES (19 pi 8 po) DE LONGUEUR**

**Homebuilt vessels and vessels where the manufacturer is unable to provide a label.**

**Bâtiments de fabrication artisanale et bâtiments dont le fabricant ne peut fournir une étiquette de conformité**

PRINT YOUR NAME AND MAILING ADDRESS IN BOX BELOW  
DANS LE CADRE CI-DESSOUS, ÉCRIVEZ VOTRE NOM ET VOTRE ADRESSE EN LETTRES MOULÉES

Name/Nom		
Street/Rue		
City/Ville ( )	Province ( )	Postal Code/Code postale
Telephone/Téléphone	Facsimile/Télocopieur	
E-mail Address (if applicable)/Adresse de courrier électronique (s'il y a lieu)		

Name/Model Number – Nom/Numéro du modèle	Model Year/Année du modèle
--	----------------------------

Hull Identification Number/Numéro d'identification de la coque	Name of Builder or Importer/Nom du fabricant ou importateur
--	---

Name of Vessel (if applicable)/Nom du bateau (s'il y a lieu)
--

Length of Vessel (in metres) Longueur du bâtiment (en mètres)	m	Width (beam) of Vessel (in millimetres) Largeur du bâtiment (en millimètres)	mm
Depth of Vessel (in millimetres) Profondeur du bâtiment (en millimètres)	mm	Transom height (in millimetres) Hauteur du tableau (en millimètres)	mm
Transom width (in millimetres) Largeur du tableau (en millimètres)	mm	Estimated Dry Weight of the vessel (in kilograms) Estimation du poids sec du bâtiment (en kilogrammes)	kg

Please provide 4 photographs showing stern view, side view, front view (taken parallel to the ground) and the seating layout, inside the vessel.

Prrière de fournir 4 photographies montrant une vue latérale, arrière, de l'avant (prises parallèle au sol) et le plan des sièges à l'intérieur.

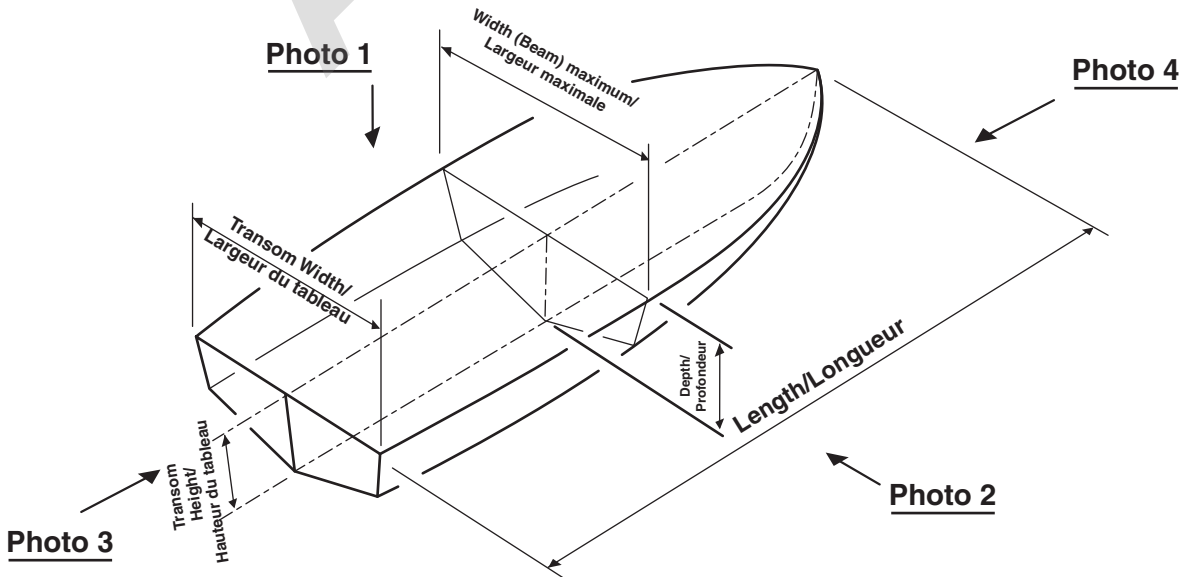

Signature of Applicant/Signature du demandeur	Date (Year/Month/Day – Année/Mois/Jour)
---	---



**APPLICATION FOR SINGLE VESSEL LABEL FOR MULTIHULL VESSELS  
UNDER 6 METRES (19 ft 8 in) IN LENGTH  
DEMANDE D'ÉTIQUETTE POUR EMBARCATION MULTICOQUE  
HORS SÉRIE DE 6 MÈTRES (19 pi 8 po) ET MOINS DE LONGUEUR**

PRINT YOUR NAME AND MAILING ADDRESS IN BOX BELOW  
DANS LE CADRE CI-DESSOUS, ÉCRIVEZ VOTRE NOM ET VOTRE ADRESSE EN LETTRES MOULÉES

\_\_\_\_\_  
\_\_\_\_\_  
\_\_\_\_\_

**ALL MEASUREMENTS TO  
BE IN MILLIMETRES**  
  
**TOUTES LES MESURES  
DOIVENT ÊTRE EN  
MILLIMÈTRES**

Telephone/Téléphone \_\_\_\_\_ Facsimile/Télécopieur \_\_\_\_\_  
**It is necessary that the following information be provided when applying for  
a capacity label for multihull vessels.**

**Fournir tous les renseignements pour obtenir une étiquette de capacité  
pour embarcation multicoque.**

Name/Model Number – Nom/Numéro du modèle	Model Year/Année du modèle
--	----------------------------

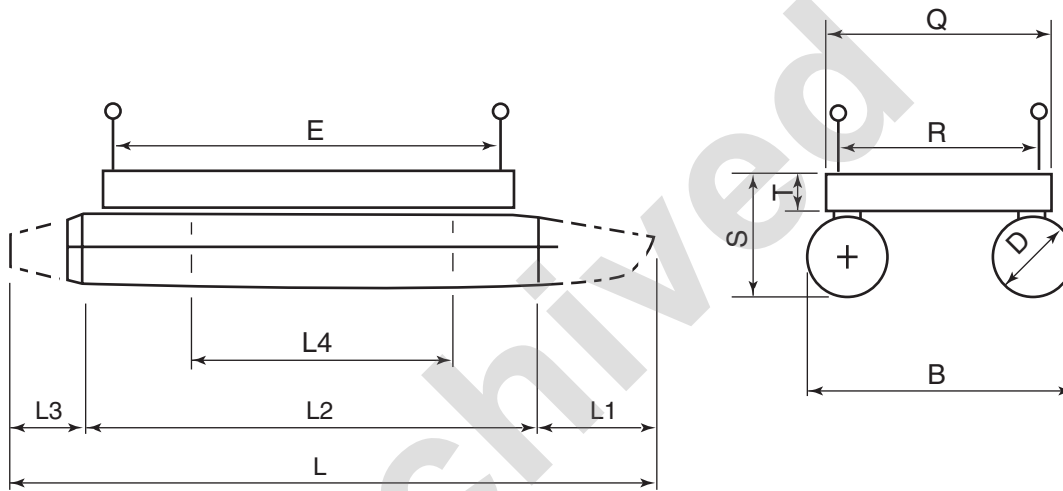

**ALL MEASUREMENTS TO BE IN MILLIMETRES/TOUTES LES MESURES DOIVENT ÊTRE EN MILLIMÈTRES**

LENGTH - LONGUEUR					
Overall/Hors tout	L	Irregular section forward (if any) Partie avant de forme irrégulière (s'il y a lieu)	L1	Parallel section/Partie parallèle	L2
	mm		mm		mm
Irregular section aft (if any) Partie arrière de forme irrégulière (s'il y a lieu)	L3	Longest space between two watertight bulkheads in any part of the pontoon (that is not foam-filled.)		Espace le plus long entre deux cloisons étanches dans n'importe quelle partie du flotteur (qui n'est pas rempli de mousse)	L4
	mm				mm

WIDTH - LARGEUR			
Maximum/Maximale	B	Diameter (external; If pontoons are not circular in cross-section, use the diameter of the largest circle that can be inscribed in the pontoon)- Diamètre (extérieur; Si les flotteurs ne sont pas circulaires, donner le diamètre du plus grand cercle qui pourrait être tracé à l'intérieur du flotteur)	D
	mm		mm

DECK - PONT			
Length Between Railings Longueur entre les garde-corps	E	Width Overall Largeur hors tout	Q
	mm		mm
Height Above Bottom of Pontoons Hauteur à partir du fond des flotteurs	S	Depth Profondeur	T
	mm		mm

Dry weight of vessel in kilograms including: pontoons, deck, railings, console, cabin, seats and any other permanent structure or fittings (Do not include engine and equipment or portable fuel tank). Le poids sec du bâtiment en kilogrammes, incluant les flotteurs, le pont, les garde-corps, la console, la cabine, les sièges et toute autre structure permanente ou accessoires (ne pas inclure le moteur et l'équipement connexe ou le réservoir de carburant portable).	kg
--	----

**NOTES**  
The rating of pontoon vessels is to be in accordance with the *Construction Standards for Small Vessels – TP1332*

**NOTA**  
La classification des bateaux pontons doit se faire conformément aux *Normes de construction des petits bateaux – TP1332*.

Please provide 4 photographs showing stern view, side view, front view (taken parallel to the ground) and the seating layout, inside the vessel.

Prière de fournir 4 photographies montrant une vue latérale, arrière, de l'avant (prises parallèle au sol) et le plan des sièges à l'intérieur.

Signature of Applicant - Signature du demandeur	Date (Year/Month/Day – Année/Mois/Jour)
---	---



**APPLICATION FOR SINGLE VESSEL LABEL FOR INFLATABLE VESSELS  
UNDER 6 METRES (19 ft 8 in) IN LENGTH  
DEMANDE D'ÉTIQUETTE POUR EMBARCATION PNEUMATIQUE  
HORS SÉRIE DE 6 MÈTRES (19 pi 8 po) ET MOINS DE LONGUEUR**

PRINT YOUR NAME AND MAILING ADDRESS IN BOX BELOW  
DANS LE CADRE CI-DESSOUS, ÉCRIVEZ VOTRE NOM ET VOTRE ADRESSE EN LETTRES MOULÉES

\_\_\_\_\_

\_\_\_\_\_

\_\_\_\_\_

**ALL MEASUREMENTS TO  
BE IN MILLIMETRES**

**TOUTES LES MESURES  
DOIVENT ÊTRE EN  
MILLIMÈTRES**

Telephone/Téléphone	Facsimile/Télécopieur
It is necessary that the following information be provided when applying for a capacity label for inflatable crafts.	
Fournir tous les renseignements pour obtenir une étiquette de capacité pour embarcation pneumatique.	
Name/Model Number – Nom/Numéro du modèle	Model Year/Année du modèle

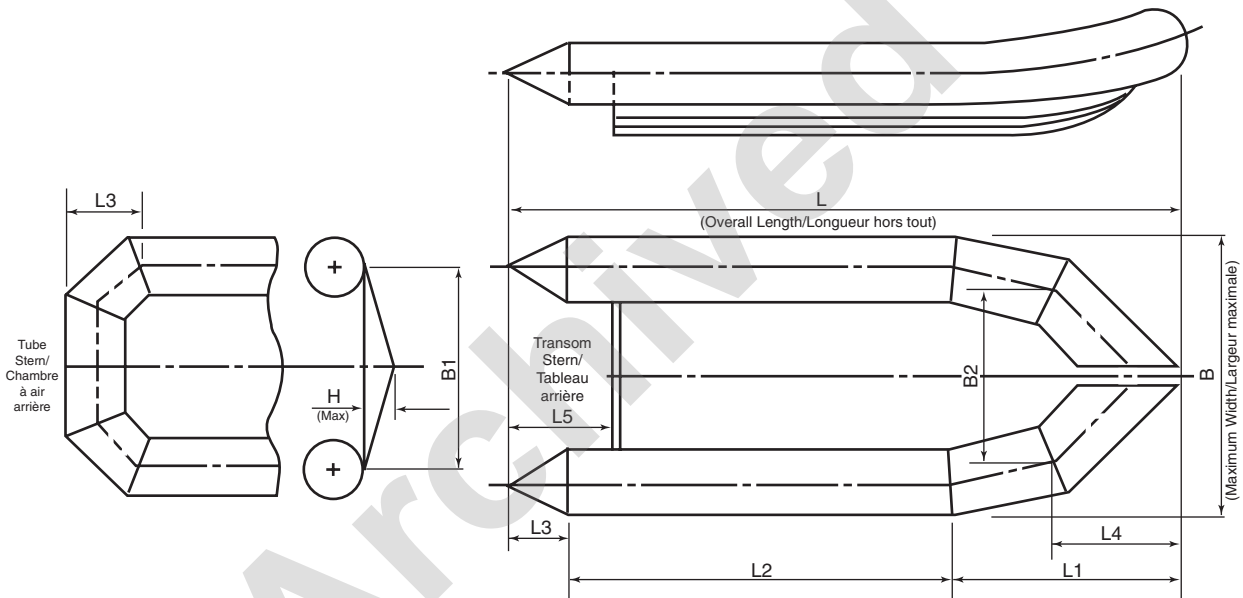

**ALL MEASUREMENTS TO BE IN MILLIMETRES/TOUTES LES MESURES DOIVENT ÊTRE EN MILLIMÈTRES**

LENGTH - LONGUEUR					
L	L1	L2	L3	L4	L5
mm	mm	mm	mm	mm	mm

WIDTH - LARGEUR				H (max)	Average Diameter of Tube Collar	D
B	B1	B2			Diamètre moyen de la chambre pneumatique	
mm	mm	mm		mm		mm

Estimated weight of Vessel in Kilograms (Do not include engine and equipment or portable fuel tank) Le poids du bateau en kilogrammes (ne pas inclure le moteur et l'équipement connexe, ou le réservoir à carburant portatif)	W
	kg

Stern Type - Type d'arrière		Bottom - Fond		Collar - Collier		Steering - Gouvernail		Forward of/ Avant de L/4
Transom À tableau	Tube À chambre	Soft Souple	Rigid Rigide	Inflatable Pneumatique	Rigid Rigide	Tiller Barre franche	Remote À distance	

Number of Buoyancy Chambers Nombre de chambres de flottaison	
---	--

Please provide 4 photographs showing stern view, side view, front view (taken parallel to the ground) and the seating layout, inside the vessel.	Prière de fournir 4 photographies montrant une vue latérale, arrière, de l'avant (prises parallèle au sol) et le plan des sièges à l'intérieur.
--	---

Signature of Applicant/Signature du demandeur	Date (Year/Month/Day – Année/Mois/Jour)
---	---

Archived

## Appendix 3.0

### SEWAGE HOLDING TANK SYSTEMS (VOLUNTARY)

**ISSUE NUMBER: 3**

**DATE: 2004 Edition**

**NUMBER OF PAGES: 5**

THIS ISSUE SUPERSEDES

Issue Number: 2

Dated: January 2002

**Where it is intended to install a Sewage Holding Tank System in a Pleasure Craft, the following guidelines (reproduced courtesy of ABYC) are recommended to be followed. Additional provincial and local design requirements may apply.**

### A3.1 System Design

#### What Are Some System Design Alternatives?

First, we'll look at some of the advantages and disadvantages of portable toilets and holding tanks in general. Later, we'll examine holding tank systems and their plumbing arrangements in greater detail.

### A3.2 Portable Toilets

#### Advantages

- Requires minimal space.
- Low cost.
- Simplicity.
- Reliability.
- Can be emptied via suction wand at a pump-out facility.
- Can be emptied ashore if pump-out facility is not available.

#### Disadvantages

- Limited capacity.

### A3.3 Holding Tank Systems

Holding Tank Systems vary in complexity depending on what they are designed to do. There are four basic arrangements.

#### 1. Deck Pump out Only

The holding tank is installed in line between the toilet and the deck pump-out fitting.

#### Advantages

- Allows use of existing toilet.
- Sewage goes directly into the tank.
- Simple to install.
- Minimal equipment requirements.
- Does not require a through hull for discharge.

#### Disadvantages

- External pump required to evacuate tank.

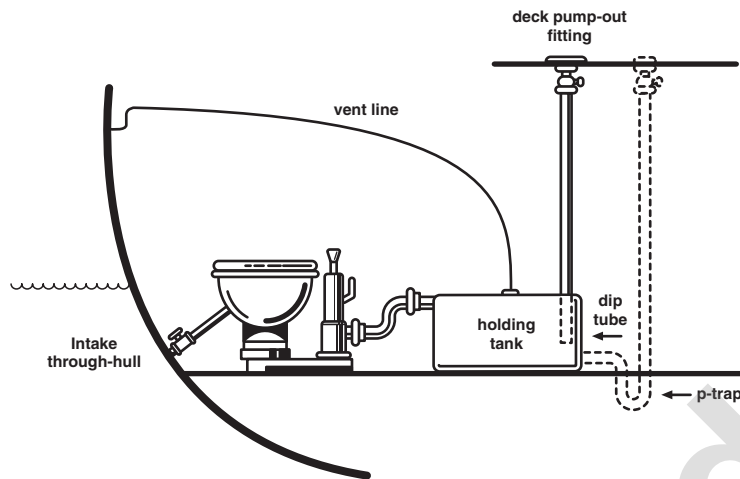
**Figure A3-1 Deck Pump Out Only**

## 2. Overboard Discharge Option After the Holding Tank

A diverter “Y” valve is installed in the line between the holding tank and deck pump-out fitting to allow the tank’s contents to be pumped overboard. The “Y” valve must be secured to prevent overboard accidental discharge.

### Advantage

- All sewage is pumped into the holding tank.
- Vessels will use pump-out facility in port.

### Disadvantages

- None.

**Note:** A “Y” valve is not required in this option. The deck pump-out fitting and the overboard through-hull valve are normally pressure tight and will function alternatively as selected. Use of a “Y” valve, however, will keep unused sections of the hose or pipe from being unnecessarily “wet” (filled with sewage) and provide an additional safeguard against accidental overboard discharge.

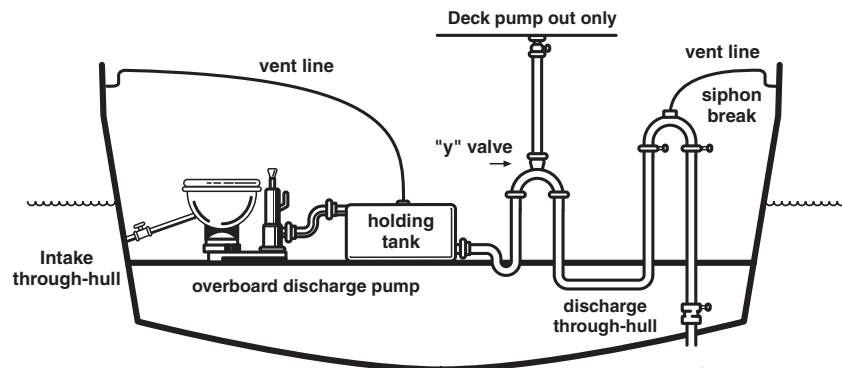
**Figure A3-2 Overboard Discharge After Holding Tank**

### 3. Overboard Discharge Options Both Before and After the Holding Tank

"Y" valves are installed in line between the toilet and holding tank and between the holding tank and deck pump-out fitting.

#### Advantages

- Flexibility in discharge options. "Y" valves must be secured to prevent accidental discharge of untreated sewage.

#### Disadvantages

- Flexibility is offset by complexity.

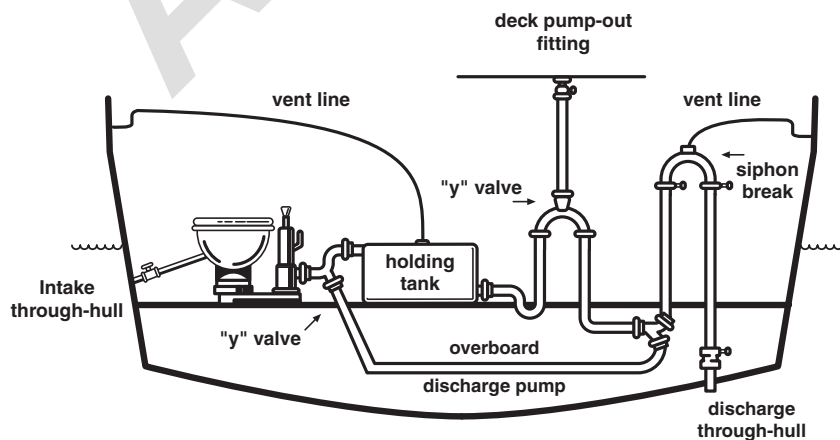
**Figure A3-3 Overboard Discharge Before and After Holding Tank**

#### 4. Overboard Discharge Option Before the Holding Tank

You should install a holding tank for use when boating in environmentally sensitive areas or when moored or dockside. A “Y” valve is installed in line between the treatment system and holding tank.

##### Advantage

- If a Type I or II treatment system is installed between the toilet and the “Y” valve, treated sewage can be pumped directly overboard, unless the vessels is in “No Discharge” waters.

##### Disadvantages

- “Y” valve must be secured to prevent accidental illegal discharge.
- External pump is required to empty holding tank.

**Figure A3-4 Overboard Discharge Before Holding Tank**

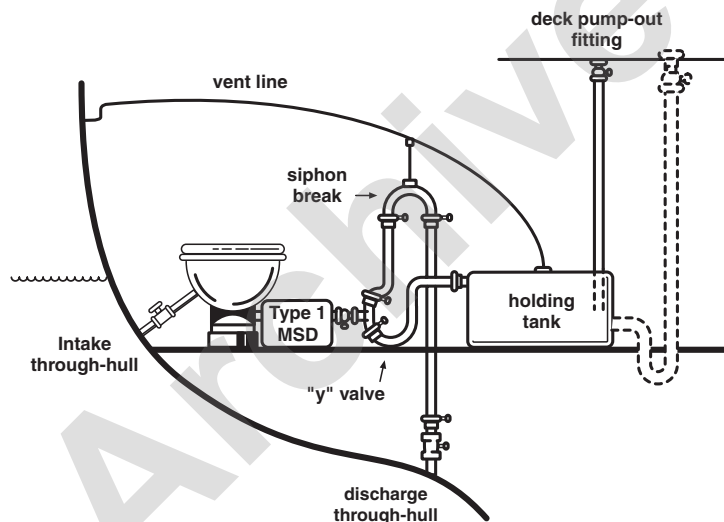

These four basic arrangements can be adapted depending on the number and type of toilets installed and whether inline waste treatment is desired.

**Appendix 4.0**

**NOISE REDUCTION ON POWER-DRIVEN  
SMALL VESSELS**

**ISSUE NUMBER: 3**  
**DATE: 2004 Edition**  
**NUMBER OF PAGES: 4**

THIS ISSUE SUPERSEDES  
Issue Number: 2  
Dated: January 2002

Archived

### A4.1 Small Vessels Noise Abatement Mechanism

#### Explanatory Note

Explanatory notes relating to the fitting of “Noise Abatement Mechanisms” on power-driven small vessels, as required by Part VI, Section 37, of the *Small Vessel Regulations* of the *Canada Shipping Act*.

Noise reduction in power-driven small vessels can be achieved in a number of ways; the following examples illustrate some acceptable solutions to addressing the issue.

- Outboard motors have addressed the issue by directing the exhaust gases through the propeller hub or below the cavitation plate.
- Inboard-outboard installations (I/Os) have addressed the issue by directing the exhaust gases through the propeller hub or below the cavitation plate.

**The installation of the following components in a wet exhaust line would be complying with the regulation:**

- A muffler is an expansion chamber within the exhaust line specifically designed to reduce engine exhaust noise.
- A waterlock is a device intended to prevent back flooding of cooling water into the exhaust manifold with a side benefit of some noise reduction.
- A diverter, used to direct exhaust gases below the waterline, is acceptable.

#### Guidance Notes and Explanation Showing Some Possible Installations

The following is provided for guidance only relating to acceptable engine exhaust noise muffling arrangements. It is not intended as an installation guide or to cover all possible installations. Engine manufacturer’s recommendations should be followed with respect to specific installations.

**Figure A4-1 Typical Dry Exhaust System**

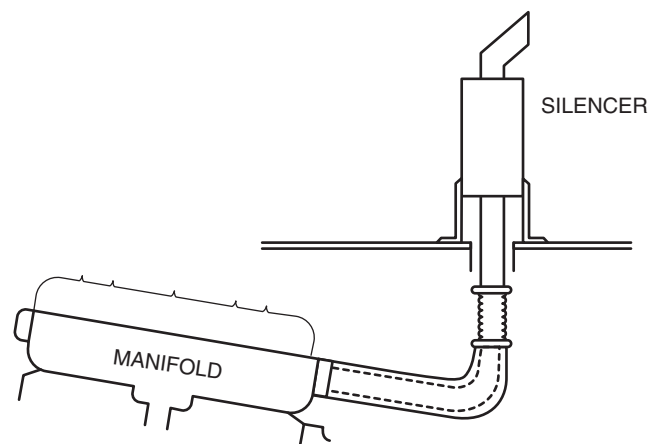

**DRY EXHAUSTS** should be equipped with a muffler (silencer) generally as indicated in Figure A4-1. The muffler should be sized as large as practical and designed to ensure maximum sound attenuation with minimum back pressure. Dry exhaust systems may be used for propulsion and generator engines of any size.

**Figure A4-2 Typical Waterlock System without muffler**

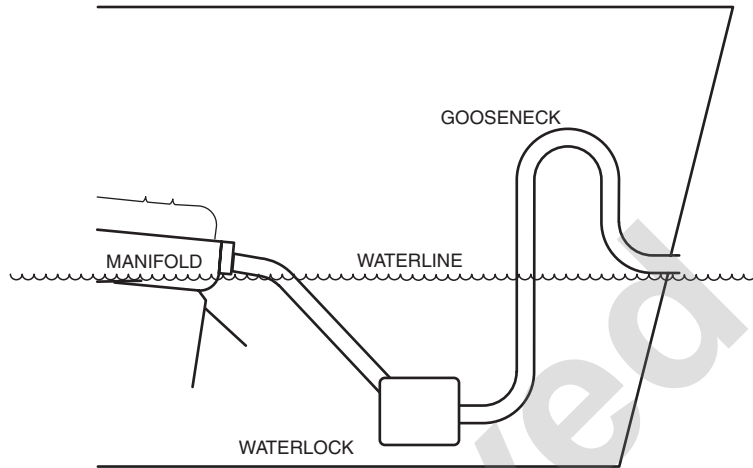

**WET EXHAUST** Systems may make use of water locks and wet mufflers, or both. Water locks alone may provide sufficient sound attenuation, and are thus suitable for generator engines and smaller propulsion engines. With all wet exhaust systems, care must be taken to ensure water cannot back-siphon into the engine. Depending on the relative height of the waterline an anti-siphon valve or siphon break may be required (not shown in figures).

**Figure A4-3 Typical Waterlock System with Muffler**

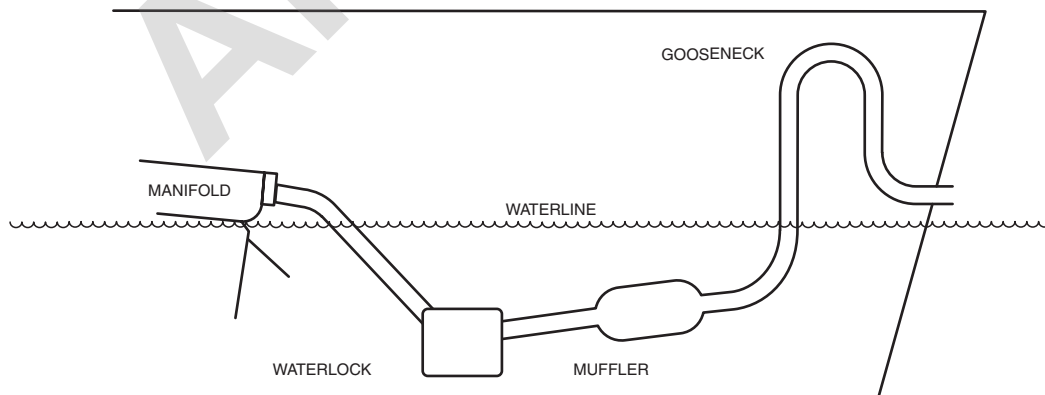

For **LARGER ENGINES** a waterlock may be supplemented with a specially designed muffler.

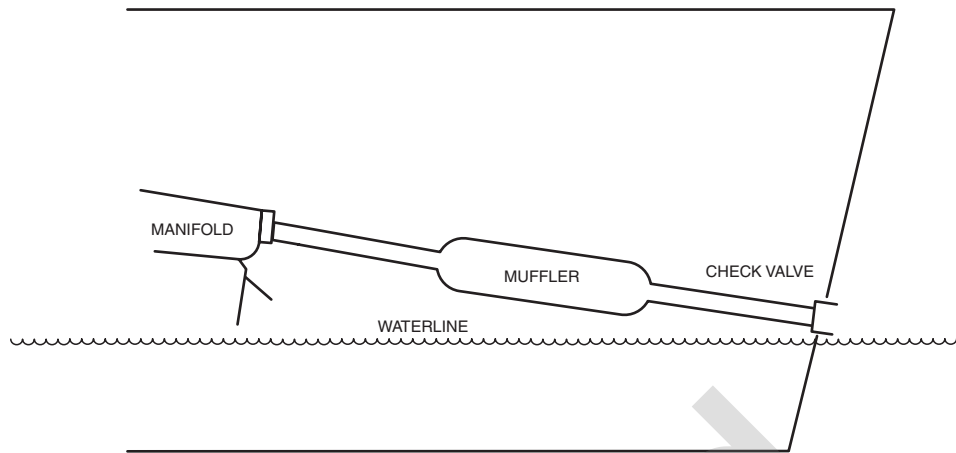
**Figure A4-4 Typical High Performance System**

For **HIGH PERFORMANCE** applications an effective muffler should be fitted. Depending on the relative height of engine to waterline, a check valve to prevent backflow of water into the engine may be required. Check valves may be at the transom, integral with the muffler or both.

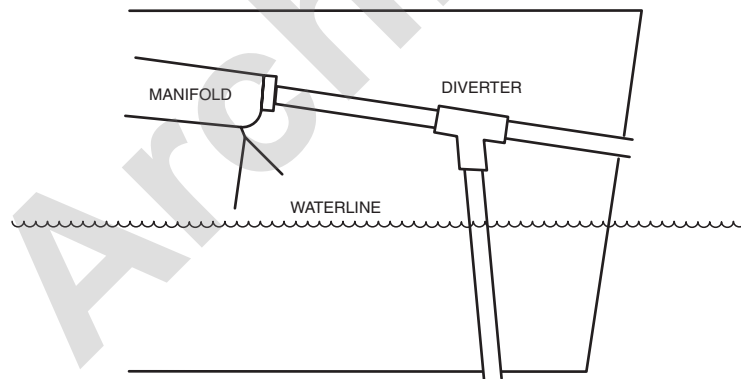
**Figure A4-5 Typical High Performance System with Diverter**

For **COMPETITION CRAFT** a diverter may be installed, allowing exhaust gases to pass without restriction where conditions permit. Where conditions require sound attenuation, the diverter is used to divert the exhaust gases through an alternate exhaust system fitted with a muffler or passing through an underwater penetration in the hull.